

Dynablast[®]

20
26

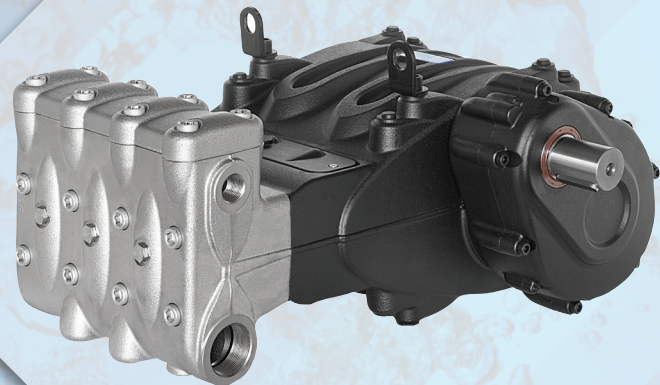

HIGH PRESSURE COMPONENTS & ACCESSORIES

TABLE OF CONTENTS

COMPONENTS & ACCESSORIES

SPRAY GUNS	6
High Pressure Spray Guns	6
Low Pressure Spray Guns	8
Spray Gun Accessories	9
GUNS & LANCE ASSEMBLIES	10
SURFACE CLEANERS	13
LANCES	14
Handles, Extensions & Single Lances	14
Single	15
Telescopic & Dual Lances	16
NOZZLES	17
Nozzle Chart	17
Nozzles	18
High Pressure Nozzles, Variable Nozzles & Holders	19
Rotating Nozzles	20
Sandblasting Nozzles	21
Tank Cleaning Nozzles	22
Drain Cleaning Nozzles	23
HIGH PRESSURE HOSES & HOSE REELS	24
High Pressure Hoses	24
Hose Reels	25
QUICK CONNECT FITTINGS, COUPLERS & CONNECTORS	27
SWIVELS, PRESSURE GAUGES & DAMPENERS	29
VALVES	32
Flow Sensitive Unloaders & Banjo Valves	32
Banjo Valves & Trapped Pressure Valves	33
Trapped Pressure Valves	34
Low Pressure Regulating Valves	35
Pressure Regulating Valves	36
Safety Relief Valves	37
Pneumatic Guns & Valves	39
Pneumatic & Ball Valves	40
Thermal Check Valves	41
Solenoid Valves	42
SWITCHES	43
Flow Switches	43
Pressure Switches	44
CHEMICAL INJECTORS, PROPORTIONERS & FOAMERS	45
FITTINGS, FILTERS & STRAINERS	48
LOW PRESSURE BALL VALVES & FITTINGS	50
Greenleaf - Ball Valves	50
Greenleaf - Cam Couplers	51
POLYPROPYLENE FITTINGS	53
HOT WATER COMPONENTS	57

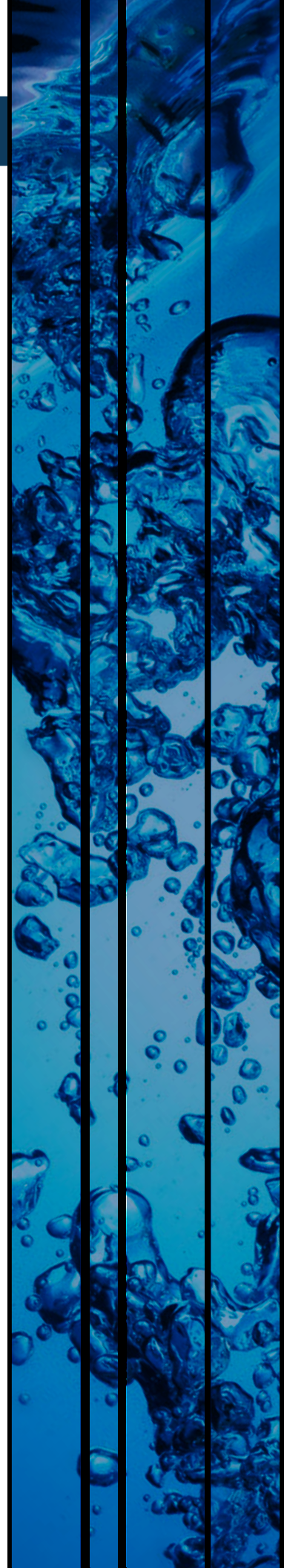

PUMPS & EQUIPMENT

ELECTRIC MOTORS & PUMP DRIVE ACCESSORIES

61

GEAR REDUCERS

63

PUMP REPAIR TOOLS

64

PUMP REPAIR KIT SELECTION GUIDE

65

INTERPUMP PUMPS

70

Evolution 1 - E1 Series Pumps

70

51 Series Pumps

71

Evolution 2 - E2 Series Pumps

72

44 Series Pumps

73

Evolution 3 - E3 Series Pumps

74

47 Series Pumps

75

66 Series Pumps

76

WK Series Pumps

77

ABB Series Pumps

78

316L SS Pumps

79

Car Wash Pumps

80

High Temperature Pumps

81

PRATISSOLI PUMPS

82

Mud Pumps & 70 Series Pumps

82

70 Series Pumps

83

71 Series Pumps

84

HY-PACK Pumps

85

High Flow Pumps

86

High Flow - Low Pressure Pumps

88

Ultra High-Pressure Pumps

89

Pump Connection Kits

91

FLOJET DIAPHRAGM PUMPS

93

ENGINEERING INFORMATION

95

WARRANTY INFORMATION

97

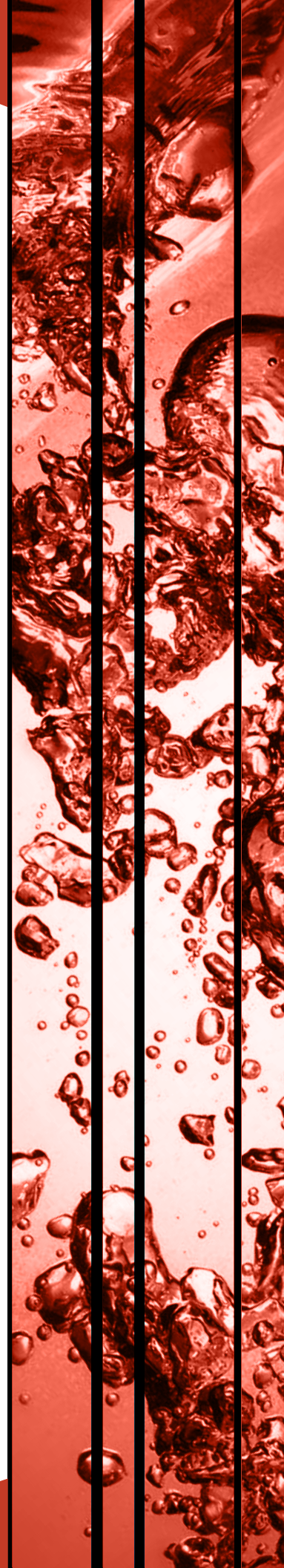

COMPONENT INDEX

SPRAY GUNS

6-9

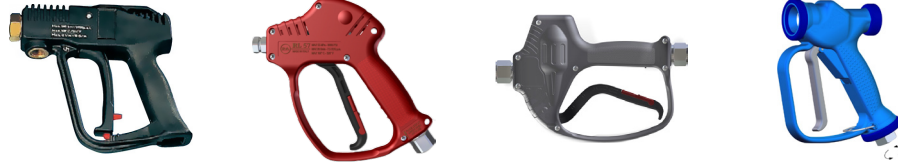

GUN & LANCE ASSEMBLY

10



SURFACE CLEANERS

13



LANCES

14-16



NOZZLES

17-23



HIGH PRESSURE HOSES & HOSE REELS

24-26



QC FITTINGS, COUPLERS CONNECTORS

27-28



SWIVELS, PRESSURE GAUGES & DAMPERS

29-31



VALVES

32-42



SWITCHES

43-44



CHEMICAL INJECTORS, PROPORTIONERS & FOAMERS

45-47



FITTINGS, FILTERS & STRAINERS

48-49



LOW PRESSURE BALL VALVES & FITTINGS

50-52



POLYPROPYLENE FITTINGS

53-57



HOT WATER COMPONENTS

57-60



COMPONENT INDEX

ELECTRIC MOTORS & PUMP DRIVE ACCESSORIES

61-62



GEAR REDUCERS

63



PUMP REPAIR TOOLS

64-69



INTERPUMP PUMPS

70-81

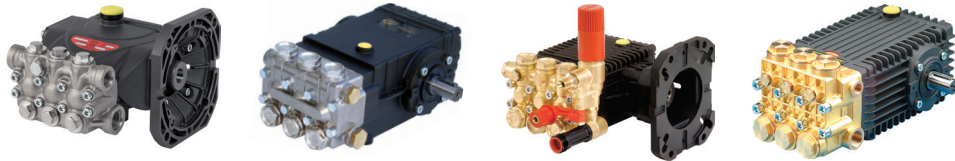

PRATISSOLI PUMPS

82-92



FLOJET - DIAPHRAGM PUMPS

93-94



P11 - SPRAY GUN

Part No.	Inlet
P11	3/8" BSP-F

- 3,000 PSI Max Pressure
- 10.5 GPM Max Flow
- 284°F Max Temperature
- 1/4" NPT-F Outlet
- Replacement Gun for Formula100 & Turbo21



P6R - CONSUMER GUN

Part No.	Inlet
P6R	

- 1,500 PSI Max Pressure
- 1.8 GPM Max Flow
- Black Abrasion Resistant Cover
- For Use with Cold Water
- Replacement Gun for KODIAK4000R



RL16 - FRONT INLET SPRAY GUN

Part No.	Inlet
RL16	3/8" NPT-F

- 2,550 PSI Max Pressure
- 8.0 GPM Max Flow
- 210°F Max Temperature
- 1/4" NPT-F Outlet



RL22 - FRONT INLET SPRAY GUN

Part No.	Inlet
RL22	3/8" NPT-F

- 5,000 PSI Max Pressure
- 10.5 GPM Max Flow
- 320°F Max Temperature
- 1/4" NPT-F Outlet



RL26 - SPRAY & WEEP GUN

Part No.	Inlet
RL26	3/8" NPT-F
RL26W	3/8" NPT-F - Weep

- 4,050 PSI Max Pressure
- 8.0 GPM Max Flow
- 320°F Max Temperature
- 1/4" NPT-F Outlet



RL37 - SPRAY GUN

Part No.	Inlet
RL37	3/8" NPT-F

- 5,000 PSI Max Pressure
- 10.5 GPM Max Flow
- 320°F Max Temperature
- 1/4" NPT-F Outlet



RL37SW2 - DOUBLE SWIVEL SPRAY GUN

Part No.	Inlet
30124700P	3/8" BSP-F - SW

- 5,000 PSI Max Pressure
- 10.5 GPM Max Flow
- 320°F Max Temperature
- 1/4" BSP-M Swivel Outlet



G250VA - SPRAY GUN

Part No.	Inlet
G250VA	3/8" NPT-F
G250VW	3/8" NPT-F - Weep
G250VASW	3/8" NPT-F - SW

- 5,000 PSI Max Pressure
- 10.5 GPM Max Flow
- 320°F Max Temperature
- 1/4" NPT-F Outlet



G250EZ - COMPENSATING GUN

Part No.	Inlet
G250EZ	3/8" NPT-F
RL26W	3/8" NPT-F swivel

- 5,000 PSI Max Pressure
- 10.5 GPM Max Flow
- 320°F Max Temperature
- 1/4" NPT-F Outlet
- 37% less force to open than G250VA
- 40% lower pressure loss than competition



G250VS - STAINLESS STEEL SPRAY GUN

Part No.	Inlet
G250VS	3/8" NPT-F

- 5,000 PSI Max Pressure
- 10.5 GPM Max Flow
- 320°F Max Temperature
- 1/4" NPT-F Outlet
- 303 Stainless Steel

Stainless Steel



RL51 - COMPENSATING GUN

Part No.	Inlet
RL51	3/8" NPT-F
RL51ARS23	3/8" NPT-F - w/ coupler & SW

- 4,050 PSI Max Pressure
- 13.2 GPM Max Flow
- 320°F Max Temperature
- 1/4" NPT-F Outlet



RL56 - COMPENSATING GUN

Part No.	Inlet
RL56	3/8" NPT-F

- 5,650 PSI Max Pressure
- 8.0 GPM Max Flow
- 320°F Max Temperature
- 1/4" NPT-F Outlet



SPRAY GUNS

HIGH PRESSURE SPRAY GUNS

RL57 - STAINLESS STEEL SPRAY GUN

Part No.	Inlet
RL57	3/8" NPT-F

- 8,100 PSI Max Pressure
- 7.5 GPM Max Flow
- 320°F Max Temperature
- 1/4" NPT-F Outlet

Stainless Steel



RL60 - CIP SYSTEMS FOAM GUN

Part No.	Inlet
RL60	1/2" BSP-F - sw

- 950 PSI Max Pressure
- 16.0 GPM Max Flow
- 210°F Max Temperature
- 1/2" BSP-F Outlet

Stainless Steel



RL34/RL82 - FOAM GUN

Part No.	Inlet
RL34 - Brass + ss	1/2" BSP-F - sw
RL82 - ss	1/2" BSP-F - sw ss

- 2,900 PSI Max Pressure
- 21.0 GPM Max Flow
- 320°F Max Temperature
- 1/2" BSP-F Outlet



RL124 - SPRAY GUN

Part No.	Inlet
RL124	1/2" BSP-F

- 1,950 PSI Max Pressure
- 32.0 GPM Max Flow
- 210°F Max Temperature
- 1/2" BSP-F Outlet
- Shoulder Rest 30506000P
- Extension Lance - Page 8



RL204 - SPRAY GUN

Part No.	Inlet
RL204	3/4" BSP-F

- 3,200 PSI Max Pressure
- 53.0 GPM Max Flow
- 210°F Max Temperature
- 1/2" BSP-F Outlet
- Shoulder Rest 30506000P
- Extension Lance - Page 8



RL84 - SPRAY GUN

Part No.	Inlet
RL84	1/2" BSP-F

- 8,100 PSI Max Pressure
- 21.0 GPM Max Flow
- 210°F Max Temperature
- 1/2" BSP-F Outlet
- Shoulder Rest 30506000P
- Extension Lance - Page 8



RL600 - STAINLESS STEEL SPRAY GUN

Part No.	Inlet
RL600	3/8" BSP-F
RL600E	3/8" BSP-F w/ reed

- 9,500 PSI Max Pressure
- 15.8 GPM Max Flow
- 210°F Rated Temperature
- 3/8" BSP-F Outlet
- Shoulder Rest 30506000P

Stainless Steel



RL1000 - PA ULTRA HIGH PRESSURE GUN

Part No.	Inlet
RL1000	3/8" NPT-F

- 16,000 PSI Max Pressure
- 10.5 GPM Max flow
- 210°F Max Temperature
- 3/8" NPT-F Outlet
- Stainless Steel

Stainless Steel



G170L - HIGH VOLUME LINEAR GUN

Part No.	Inlet
G170L	1/2" NPT-F

- 2,800 PSI Max Pressure
- 27.0 GPM Max Flow
- 195°F Max Temperature
- 1/2" NPT-F Outlet



G280L - HIGH VOLUME LINEAR GUN

Part No.	Inlet
G280L	1/2" NPT-F

- 4,500 PSI Max Pressure
- 32.0 GPM Max Flow
- 320°F Max Temperature
- 1/2" NPT-F Outlet



G85LN - LINEAR GUN

Part No.	Inlet
G85LN	3/8" NPT-F
G85LNSW	3/8" NPT-F - sw

- 5,000 PSI Max Pressure
- 10.5 GPM Max Flow
- 320°F Max Temperature
- 1/4" NPT-F Outlet



G250L - HIGH VOLUME LINEAR GUN

Part No.	Inlet
G250L	1/2" NPT-F

- 3,625 PSI Max Pressure
- 21.0 GPM Max Flow
- 210°F Max Temperature
- 1/2" NPT-F Outlet



RB35 - WASHDOWN GUN

Part No.	Inlet
RB35	1/2" BSP-F - sw

- 175 PSI Max Pressure
- 13.2 GPM Max Flow
- 120°F Max Temperature
Viton Seals - RB35-50
- 176°F Max Temperature
EPDM Seals - RB35-80
- Adjustable Spray Pattern
- Brass



RB35OE/OV - ON/OFF WASHDOWN GUN

Part No.	Inlet
RB35OE/OV	1/2" BSP-F - sw

- 175 PSI Max Pressure
- 13.2 GPM Max Flow
- 120°F Max Temperature
Viton Seals - RB35OV
- 176°F Max Temperature
EPDM Seals - RB35OE
- Extension Lance Available (See Below)
- Stainless Steel

Stainless Steel



RB65 - WASHDOWN GUN

Part No.	Inlet
RB65	1/2" BSP-F
RB65SW	1/2" BSP-F - sw
RB65HF	1/2" BSP-F

- 350 PSI Max Pressure
- 16.0 GPM Max Flow - RB65/RB65SW
- 26.5 GPM Max Flow - RB65HF
- Adjustable Spray Pattern
- Brass



RB65SS - WASHDOWN GUN

Part No.	Inlet
RB65SS	1/2" BSP-F

- 350 PSI Max Pressure
- 16.0 GPM Max Flow
- Adjustable Spray Pattern
- Stainless Steel

Stainless Steel



RLD - SPRAY GUN

Part No.	Inlet
RLD	1/2" BSP-M

- 73 PSI Max Pressure
- 4.68 GPM Max Flow
- 140°F Max Temperature
- Chrome Plated Brass



NOTE:
Garden Hose
Adapter available:
SGM0004BR - Page 48

LOW PRESSURE SPRAY GUN ACCESSORIES

RB35OE/OV - EXTENSION LANCES

Part No.	Length
99030001P	11.81"
99030002P	23.62"
99030004P	35.43"

- 175 PSI Max Pressure
- 13.2 GPM Max Flow
- 176°F Max Temp
- Stainless Steel



Stainless Steel

SW65 - BRASS SWIVEL

Part No.	Inlet
SW65	1/2 BSP-M - sw

- 350 PSI Rated Pressure
- Up to 26.5 GPM Max Flow
- Swivel Option for RB65



HIGH PRESSURE SPRAY GUN ACCESSORIES

PA FOOT PEDAL

Part No.	Pressure/ Flow
30216000P	5,000 PSI @ 10.5 GPM

- 195°F Max Temperature
- 3/8" NPT-F Inlet
- 1/4" NPT-F Outlet
- Featuring G250VA Gun

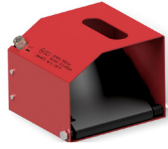

FOOT PEDAL

Part No.	Pressure/ Flow
FP3000	3,000 PSI @ 8.0 GPM
FP5000	5,000 PSI @ 12.0 GPM

- 300°F Max Temperature
- 3/8" NPT-F Inlet
- 1/4" NPT-F Outlet
- Protective Coating

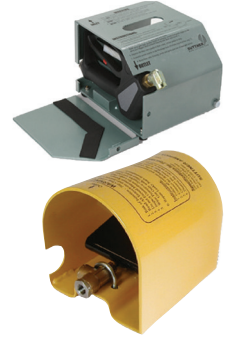

VARIOPRESS PRESSURE VARIATOR

Part No.	Inlet
VARIOPRESS	1/4" BSP-F

- 3,000 PSI Max Pressure
- 5.5 GPM Max Flow
- 176°F Max Temperature
- 1/4" BSP-F Outlet



FLOW REGULATOR

Part No.	Inlet
FRI	1/4" BSP-M

- 3,650 PSI Max Pressure
- 8.0 GPM Max Flow
- 320°F Max Temperature
- 1/4" BSP-F Outlet



CONSUMER GUN, LANCE, HOSE ASSEMBLY - ELECTRIC

Part No.	Hose Inlet/ Outlet
GLHPKE	M22-F x M22-M

- 1,900 PSI Spray Gun
- 20' High Pressure Hose
- Chemical Bottle
- 2 Lances - Vario and Roto



CONSUMER GUN, LANCE, HOSE ASSEMBLY - GAS USE

Part No.	Hose Inlet/ Outlet
GLHPKG	M22-F x M22-M

- 2,700 PSI Spray Gun
- High-Low 3.5 Nozzle
- 25' Hose
- For Consumer Gas Pressure Washers
- Lance Length: 16"



TURBOGUN GUN, LANCE ASSEMBLY

Part No.	Inlet	Outlet
TURBOGUN	1/4" BSP-M	1/4" BSP-F

- 3,000 PSI Max Pressure
- Lance Length: 36"
- 10.5 GPM Max Flow
- Gun Assembly for Turbo21 & Formula100
- 284°F Max Temperature



RL300 FOAMING GUN

Part No.	Inlet	Nozzle Size
RL3001.8	3/8" BSP-F - SW	1.8 - 2.6 GPM
RL3002.1		2.1 - 4.0 GPM

- 3,200 PSI Max Pressure
- Dual Lance with LS12 Foamer Nozzle Protector
- Up to 4.0 GPM Max Flow
- 140°F Max Temperature



PA GUN, LANCE, QC ASSEMBLY

Part No.	Inlet	Outlet
GLQC4000PKG	3/8" NPT-F	QC

- 4,500 PSI Max Pressure
- 320°F Max Temperature
- 10.5 GPM Max Flow
- Lance Length: 36" with QC



RL37SW GUN & LANCE ASSEMBLY

Part No.	Inlet	Outlet
30126210P	3/8" BSP-F - SW	1/4" NPT-F

- 4,500 PSI Max Pressure
- 320°F Max Temperature
- 10.5 GPM Max Flow
- Swivel Lance Length: 47"



ECONOMICAL 4,000 PSI GUN, LANCE, QC ASSEMBLY

Part No.	Inlet	Outlet
EGLQC4000	3/8" QC-M	QC

- 4,000 PSI Max Pressure
- 300°F Max Temperature
- 7.0 GPM Max Flow
- Lance Length: 36" with QC



ECONOMICAL 5,000 PSI GUN, LANCE, QC ASSEMBLY

Part No.	Inlet	Outlet
GLQC5000	3/8" NPT-F	QC

- 5,000 PSI Max Pressure
- 320°F Max Temperature
- 10.0 GPM Max Flow
- Lance Length: 36" with QC



GUN & LANCE ASSEMBLIES

COMPENSATING GUN, LANCE ASSEMBLY

Part No.	Inlet	Outlet
RL56S31200	3/8" NPT-F	1/4" NPT-F

- 5,650 PSI Max Pressure
- 8.0 GPM Max Flow
- 320°F Max Temperature
- Lance Length: 47"



RL600SS GUN & LANCE ASSEMBLY

Part No.	Inlet	Outlet
30588000P	3/8" BSP-F	1/4" NPT-F

- 9,500 PSI Max Pressure
- 15.8 GPM Max Flow
- 210°F Max Temperature
- Stainless Steel



RL1000 GUN & LANCE ASSEMBLY

Part No.	Inlet	Outlet
30592000P	3/8" BSP-F	1/4" NPT-F
30592050P	3/8" NPT-F	

- 16,000 PSI Max Pressure
- 10.5 GPM Max Flow
- 210°F Max Temperature
- Lance Length: 25.2" - 30592000P
348.4" - 30592050P

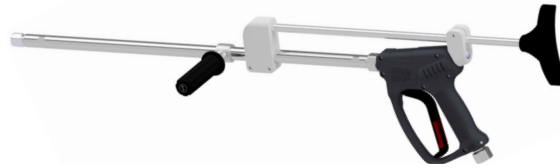

WEEP GUN ASSEMBLY

Part No.	Inlet	Outlet
30076700P	3/8" BSP-F - SW	1/4" NPT-F
30076806P		

- 4,050 PSI Max Pressure
- 8.0 GPM Max Flow
- 320°F Max Temperature
- Lance Length: 27.5" - 30076700P
35.4" - 30076806P



PA HIGH VOLUME INDUSTRIAL GUN, LANCE, NOZZLE ASSEMBLY (RL124)

Part No.	Inlet	Nozzle Size
30538250P	1/2" BSP-F	4.5mm

- 1,950 PSI Max Pressure
- 32.0 GPM Max Flow
- 110°F Max Temperature
- Lance Length: 28"

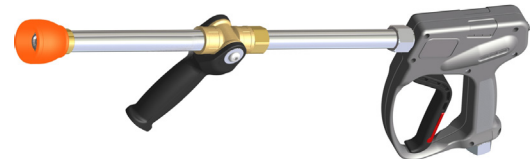

WASHDOWN GUN ASSEMBLY (RL36)

Part No.	Inlet	Nozzle Size
30158520P	3/8" NPT-F	2mm (#12)

- 4,500 PSI Max Pressure
- 8.0 GPM Max Flow
- 195°F Max Temperature
- Lance Length: 37"



WASHDOWN GUN ASSEMBLY (RL51)

Part No.	Inlet	Nozzle Size
30414530P	3/8" NPT-F	3mm (#25)

- 4,050 PSI Max Pressure
- 10.5 GPM Max Flow
- 195°F Max Temperature
- Lance Length: 37"



WASHDOWN GUN ASSEMBLY (RL34)

Part No.	Inlet	Nozzle Size
30292835P	1/2" BSP-F - SW	3.7mm (#35)

- 2,900 PSI Max Pressure
- 21.0 GPM Max Flow
- 110°F Max Temperature
- Lance Length: 33"



HYPRO HIGH VOLUME GUN, LANCE, NOZZLE ASSEMBLY

Part No.	Inlet	Nozzle Size
AG33810010	1/2" NPT-M	3mm - 25 GPM
AG33810011	1/2" NPT-M	4mm - 30 GPM

- 1,200 PSI Max Pressure
- 30.0 GPM Max Flow
- Lance Length:
 - 17" - AG33810010
 - 21" - AG33810011



HYPRO LOW PRESSURE-HIGH VOLUME GUN, LANCE, NOZZLE ASSEMBLY

Part No.	Inlet	Nozzle Size
AG33810013	1/2" NPT-M	3mm

- 700 PSI Max Pressure
- 19.0 GPM Max Flow
- Lance Length: 7"



HYPRO LOW PRESSURE GUN, LANCE, NOZZLE ASSEMBLY

Part No.	Inlet	Nozzle Size
AG33810043	3/8" & 1/2" HB	2.3mm
AG33810043L		

- 600 PSI Max Pressure
- 4.5 GPM Max Flow
- Lance Length:
 - 7.25" - AG33810043
 - 18" - AG33810043L



SURFACE CLEANERS

WATER BROOMS

Part No.	Inlet	Outlet
WB12	1/4" NPT-F	1/4" NPT-F
WB16	1/4" NPT-F	1/4" NPT-F
GP2100306	1/4" NPT-F	1/4" NPT-F

- 3,000 PSI Max Pressure
- Deluxe 4,500 PSI:
- Length:
 - 12" - WB12
 - 16" - WB16



SURFACE CLEANER

Part No.
SC18P

- 4,000 PSI Max Pressure
- 8.0 GPM Max Flow
- 212°F Max Temperature
- 18" Body Diameter
- Supported by 2.0" Casters
- Includes Spray Gun, Hose & Nozzles
- 2 Arm Nozzle Bar
- 25° Nozzle Installed



STAINLESS STEEL SURFACE CLEANER

Part No.
SC20

- 4,000 PSI Max Pressure
- 8.0 GPM Max Flow
- 212°F Max Temperature
- 20" Body Diameter
- Supported by 2.5" Casters
- Includes Spray Gun, Hose & Nozzles
- 2 Arm Nozzle Bar
- 25° Nozzle Installed
- Stainless Steel



Stainless Steel

UNDER CARRIAGE SURFACE CLEANER

Part No.
UCC4000SS

- 4,000 PSI Max Pressure
- 8.0 GPM Max Flow
- 212°F Max Temperature
- 20" Stainless Steel Body
- 25° Nozzle Installed
- Includes Spray Gun, Hose & Nozzles



NEW!

Stainless Steel



SINGLE LANCE UNIVERSAL SIDE HANDLE

Part No.	Description
SH	Fits all 1/4" Single Lance Tubes



PA STAINLESS STEEL LANCE TUBES

Part No.	Length	Grip
40746022P	17.7"	Round
40771022P	27.5"	Round
40901022P	35.4"	Round

- 3,650 PSI Max Pressure
- 10.5 GPM Max Flow
- 320°F Max Temperature
- 1/4" NPT-M Inlet/ Outlet



Stainless Steel

EXTENSION LANCES

Part No.	Length	Compatible With
30400040P	16"	RL124
30400080P	32"	

- 1,750 PSI Max Pressure
- 26.5 GPM Max Flow
- 230°F Max Temperature
- 1/2" BSP-M Inlet
- 1/4" NPT-F Outlet
- Zinc Plated



STAINLESS STEEL EXTENSION LANCES

Part No.	Length	Compatible With
30500040P	16"	RL84 & RL204
30500080P	32"	
30500092P	50"	

- 7,250 PSI Max Pressure
- 26.5 GPM Max Flow
- 230°F Max Temperature
- 1/2" BSP-M Inlet
- 1/4" NPT-F Outlet



Stainless Steel

FLEXIBLE WANDS

Part No.	Length	Colour
DL18FWBK	1/4" NPT-M/1/8" NPT-F	Black
DL18FWBKM	1/4" NPT-M/1/4" NPT-F	Black
DL18FWBLM	1/4" NPT-M/1/4" NPT-F	Blue
DL18FWRDM	1/4" NPT-M/1/4" NPT-F	Red

- 2,250 PSI Max Pressure
- 10 GPM Max Flow
- 320°F Max Temperature
- 1/4" NPT-M Inlet
- 1/4" NPT-F Outlet
- Zinc Plated



PISTOL GRIP EXTENSION

Part No.	Inlet	Outlet
357R03F02F	3/8" NPT-F	1/4" NPT-F

- 2,000 PSI Max Pressure
- Includes 18" Extension



ECONOMICAL LANCES

Part No.	Length	Grip
L18ICP	18"	Round
L24ICP	24"	Round
L1	36"	Round
L2	48"	Round

- 4,000 PSI Max Pressure
- 1/4" NPT-M Inlet/ Outlet
- Round Molded Grip
- Zinc Plated



ECONOMICAL TWO-SECTION LANCE

Part No.	Length	Grip
L7	36"	Round

- 4,000 PSI Max Pressure
- 1/4" NPT-M Inlet/ Outlet
- Round Molded Grip
- Zinc Plated



ECONOMICAL STAINLESS STEEL LANCES

Part No.	Length	Grip
L5	24"	Round
L6	48"	Rectangular

- 4,000 PSI Max Pressure
- 1/4" NPT-M Inlet/ Outlet



PA ECONOMICAL MOLDED GRIP LANCES

Part No.	Length	Grip
L50S	19.7"	Square
L70	27.5"	Square
L90	35.4"	Square
L120	42.7"	Square

- 3,650 PSI Max Pressure
- 10.5 GPM Max Flow
- 320°F Max Temperature
- 1/4" NPT-M Inlet
- 1/4" NPT-F Outlet
- Zinc Plated



PA S3 5,100 PSI STAINLESS STEEL LANCES

Part No.	Length	Grip
L800SS	31"	Vented
L1050SS	41"	Vented
L1200SS	47"	Vented

- 5,100 PSI Max Pressure
- 8.0 GPM Max Flow
- 320°F Max Temperature
- 1/4" NPT-M Inlet
- 1/4" NPT-F Outlet



INTERPUMP VENTED LANCES

Part No.	Length	Grip
Z7	27"	Vented
Z9	35"	Vented
Z12	47"	Vented
Z15	59"	Vented
Z17	67"	Vented
Z20	79"	Vented

- 3,000 PSI Max Pressure
- 10.56 GPM Max Flow
- 284°F Max Temperature
- 1/4" BSP-M Inlet
- 1/4" BSP-F Outlet
- Zinc Plated



PA S3 VENTED GRIP LANCES

Part No.	Length	Grip
40053500P	19.6"	Vented
40075500P	27.5"	Vented
40095500P	35.4"	Vented
40125500P	47.2"	Vented
40155500P	59"	Vented

- 3,650 PSI Max Pressure
- 10.5 GPM Max Flow
- 320°F Max Temperature
- 1/4" NPT-M Inlet
- 1/4" NPT-F Outlet
- Zinc Plated



PA S6 HIGH PRESSURE VENTED GRIP STAINLESS STEEL LANCES

Part No.	Length	Grip
40016080P	31.5"	Vented
40016012P	47.3"	Vented

- 8,700 PSI Max Pressure
- 15.8 GPM Max Flow
- 210°F Max Temperature
- 3/8" BSP-M Inlet
- 1/4" NPT-F Outlet



TELESCOPIC WANDS

Part No.	Length
DLTG12N	6' - 12'
DLTG18N	6' - 18'
DLTG24N	6' - 24'

Part No.	Description
D20015	Wand Belt
D20011	Gutter Cleaner

- 3,500 PSI Max Pressure
- 8.0 GPM Max Flow
- 300°F Max Temperature
- 3/8" NPT-F Inlet
- 1/4" QC Outlet

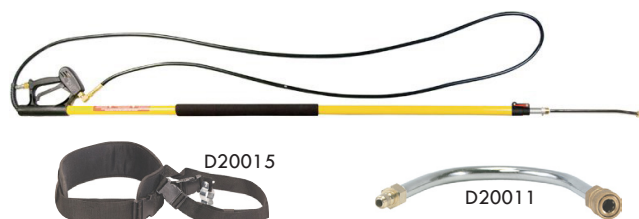

HEAVY DUTY TELESCOPING WAND WITH COMPENSATING GUN

Part No.	Length
DLTG24A	6 - 24"

- 4,000 PSI Max Pressure
- 10.5 GPM Max Flow
- 300°F Max Temperature
- 3/8" NPT-F Inlet
- 1/4" QC Outlet
- Aluminum Pole
- Compensating Gun
- Includes D20015 Wand Belt



PA DUAL LANCE

Part No.	Length	Grip
LL890	35"	Vented
LL1090	43"	Vented

- 3,650 PSI Max Pressure
- 10.5 GPM Max Flow
- 320°F Max Temperature
- 1/4" NPT-M Inlet
- 1/4" NPT-F Outlet
- Zinc Plated



PA STAINLESS STEEL DUAL LANCE

Part No.	Length	Grip
LL890SS	35"	Vented
LL1090SS	43"	Vented

- 3,650 PSI Max Pressure
- 10.5 GPM Max Flow
- 320°F Max Temperature
- 1/4" NPT-M Inlet
- 1/4" NPT-F Outlet
- Stainless Steel



Stainless Steel

PA DUAL LANCE WITH VERTICAL KNOB

Part No.	Length	Grip
LL1090V	43"	Vented

- 3,650 PSI Max Pressure
- 10.5 GPM Max Flow
- 320°F Max Temperature
- 1/4" NPT-M Inlet
- 1/4" NPT-F Outlet
- Zinc Plated



PA STAINLESS STEEL DUAL LANCE WITH VERTICAL KNOB

Part No.	Length	Grip
LL1090VSS	43"	Vented

- 3,650 PSI Max Pressure
- 10.5 GPM Max Flow
- 320°F Max Temperature
- 1/4" NPT-M Inlet
- 1/4" NPT-F Outlet
- Stainless Steel



Stainless Steel

PA HIGH PRESSURE DUAL LANCE

Part No.	Length	Grip
41070000P	43"	Vented

- 4,500 PSI Max Pressure
- 10.5 GPM Max Flow
- 320°F Max Temperature
- 1/4" BSP-M Inlet, 1/4" NPT-F Outlet
- Zinc Plated, Insulated Molded
- SS Removable Valve Seat making it easily serviceable



INTERPUMP DUAL LANCE

Part No.	Length	Grip
ZZ10	35"	Insulated
ZZ18	74"	Insulated

- 3,000 PSI Max Pressure
- 10.56 GPM Max Flow
- 284°F Max Temperature
- 1/4" NPT-M Inlet
- 1/4" NPT-F Outlet
- Zinc Plated



NOZZLE CHART

A commonly used standard for nozzle size is the "nozzle number" which is equivalent to the nozzle capacity in GPM at a specific PSI. Spray angle does not effect nozzle volume.

Size	Orifice Diameter		Pressure (PSI)																												
	inches	mm	5	10	20	30	40	100	250	500	750	1000	1250	1500	1750	2000	2250	2500	2750	3000	3250	3500	3750	4000	4500	5000	5500	6000	6500	7000	7500
1	0.026	0.66	0.04	0.05	0.07	0.09	0.10	0.16	0.25	0.35	0.43	0.50	0.56	0.61	0.66	0.71	0.74	0.79	0.83	0.87	0.90	0.94	0.97	1.00	1.06	1.12	1.17	1.22	1.27	1.32	1.37
1.5	0.031	0.79	0.05	0.08	0.11	0.13	0.15	0.24	0.38	0.53	0.65	0.75	0.84	0.92	0.99	1.06	1.11	1.19	1.24	1.30	1.35	1.40	1.45	1.50	1.59	1.68	1.76	1.84	1.91	1.98	2.05
2	0.034	0.86	0.07	0.10	0.14	0.17	0.20	0.32	0.50	0.71	0.87	1.00	1.12	1.22	1.32	1.41	1.48	1.58	1.66	1.73	1.80	1.87	1.94	2.00	2.12	2.24	2.35	2.45	2.55	2.65	2.74
2.5	0.039	0.99	0.09	0.13	0.18	0.22	0.25	0.40	0.63	0.88	1.08	1.25	1.40	1.53	1.65	1.77	1.85	1.98	2.07	2.17	2.25	2.34	2.42	2.50	2.65	2.80	2.93	3.06	3.19	3.31	3.42
3	0.043	1.09	0.11	0.15	0.21	0.26	0.30	0.47	0.75	1.06	1.30	1.50	1.68	1.84	1.98	2.12	2.22	2.37	2.49	2.60	2.70	2.81	2.90	3.00	3.18	3.35	3.52	3.67	3.82	3.97	4.11
3.5	0.048	1.22	0.12	0.18	0.25	0.30	0.35	0.55	0.88	1.24	1.52	1.75	1.96	2.14	2.32	2.47	2.60	2.77	2.90	3.03	3.15	3.27	3.39	3.50	3.71	3.91	4.10	4.29	4.46	4.63	4.79
4	0.050	1.27	0.14	0.20	0.28	0.35	0.40	0.63	1.00	1.41	1.73	2.00	2.24	2.45	2.65	2.83	2.97	3.16	3.32	3.46	3.61	3.74	3.87	4.00	4.24	4.47	4.69	4.90	5.10	5.29	5.48
4.5	0.055	1.40	0.16	0.23	0.32	0.39	0.45	0.71	1.13	1.59	1.95	2.25	2.52	2.76	2.98	3.18	3.34	3.56	3.73	3.90	4.06	4.21	4.36	4.50	4.77	5.03	5.28	5.51	5.74	5.95	6.16
5	0.057	1.45	0.18	0.25	0.35	0.43	0.50	0.79	1.25	1.77	2.17	2.50	2.80	3.06	3.31	3.54	3.71	3.95	4.15	4.33	4.51	4.68	4.84	5.00	5.30	5.59	5.86	6.12	6.37	6.61	6.85
5.5	0.060	1.52	0.19	0.28	0.39	0.48	0.55	0.87	1.38	1.94	2.38	2.75	3.07	3.37	3.64	3.89	4.08	4.35	4.56	4.76	4.96	5.14	5.33	5.50	5.83	6.15	6.45	6.74	7.01	7.28	7.53
6	0.062	1.57	0.21	0.30	0.42	0.52	0.60	0.95	1.50	2.10	2.60	3.00	3.35	3.67	3.97	4.24	4.45	4.74	4.97	5.20	5.41	5.61	5.81	6.00	6.36	6.71	7.04	7.35	7.65	7.94	8.22
6.5	0.064	1.63	0.23	0.33	0.46	0.56	0.65	1.03	1.63	2.30	2.81	3.25	3.63	3.98	4.30	4.60	4.82	5.14	5.39	5.63	5.86	6.08	6.29	6.50	6.89	7.27	7.62	7.96	8.29	8.60	8.90
7	0.067	1.70	0.25	0.35	0.49	0.61	0.70	1.11	1.75	2.47	3.03	3.50	3.91	4.29	4.63	4.95	5.19	5.53	5.80	6.06	6.31	6.55	6.78	7.00	7.42	7.83	8.21	8.57	8.92	9.26	9.59
7.5	0.071	1.80	0.27	0.38	0.53	0.65	0.75	1.19	1.88	2.65	3.25	3.75	4.19	4.59	4.96	5.30	5.56	5.93	6.22	6.50	6.76	7.02	7.26	7.50	7.95	8.39	8.79	9.19	9.56	9.92	10.27
8	0.072	1.83	0.28	0.40	0.57	0.69	0.80	1.26	2.00	2.83	3.46	4.00	4.47	4.90	5.29	5.66	5.93	6.32	6.63	6.93	7.21	7.48	7.75	8.00	8.49	8.94	9.38	9.80	10.20	10.58	10.95
8.5	0.074	1.88	0.30	0.43	0.60	0.74	0.85	1.34	2.13	3.01	3.68	4.25	4.75	5.21	5.62	6.01	6.30	6.72	7.05	7.36	7.66	7.95	8.23	8.50	9.02	9.50	9.97	10.41	10.84	11.24	11.64
9	0.076	1.93	0.32	0.45	0.64	0.78	0.90	1.42	2.25	3.18	3.90	4.50	5.03	5.51	5.95	6.36	6.67	7.12	7.46	7.79	8.11	8.42	8.71	9.00	9.55	10.06	10.55	11.02	11.47	11.91	12.32
9.5	0.078	1.98	0.34	0.48	0.67	0.82	0.95	1.50	2.38	3.36	4.11	4.75	5.31	5.82	6.28	6.72	7.05	7.51	7.88	8.23	8.56	8.89	9.20	9.50	10.08	10.62	11.14	11.64	12.11	12.57	13.01
10	0.080	2.03	0.35	0.50	0.71	0.87	1.00	1.58	2.50	3.54	4.33	5.00	5.59	6.12	6.61	7.07	7.42	7.91	8.29	8.66	9.01	9.35	9.68	10.00	10.61	11.18	11.73	12.25	12.75	13.23	13.69
11	0.083	2.11	0.39	0.55	0.78	0.95	1.10	1.74	2.75	3.89	4.76	5.50	6.15	6.74	7.28	7.78	8.16	8.70	9.12	9.53	9.92	10.29	10.65	11.00	11.67	12.30	12.90	13.47	14.02	14.55	15.06
12	0.087	2.21	0.42	0.60	0.85	1.04	1.20	1.90	3.00	4.24	5.20	6.00	6.71	7.35	7.94	8.49	8.90	9.49	9.95	10.39	10.82	11.22	11.62	12.00	12.73	13.42	14.07	14.70	15.30	15.87	16.43
12.5	0.089	2.26	0.44	0.63	0.88	1.08	1.25	1.98	3.13	4.42	5.41	6.25	6.99	7.65	8.27	8.84	9.27	9.88	10.36	10.83	11.27	11.69	12.10	12.50	13.26	13.98	14.66	15.31	15.93	16.54	17.12
13	0.091	2.31	0.46	0.65	0.92	1.13	1.30	2.06	3.25	4.60	5.63	6.50	7.27	7.96	8.60	9.19	9.64	10.28	10.78	11.26	11.72	12.16	12.59	13.00	13.79	14.53	15.24	15.92	16.57	17.20	17.80
14	0.093	2.36	0.49	0.70	0.99	1.21	1.40	2.21	3.50	4.95	6.06	7.00	7.88	8.57	9.26	9.90	10.38	11.07	11.61	12.12	12.62	13.10	13.56	14.00	14.85	15.65	16.42	17.15	17.85	18.52	19.17
15	0.096	2.44	0.53	0.75	1.06	1.30	1.50	2.37	3.75	5.30	6.50	7.50	8.39	9.19	9.92	10.61	11.12	11.86	12.44	12.99	13.52	14.03	14.52	15.00	15.91	16.77	17.59	18.37	19.12	19.84	20.54
20	0.109	2.77	0.71	1.00	1.41	1.73	2.00	3.16	5.00	7.07	8.66	10.00	11.18	12.25	13.23	14.14	14.83	15.81	16.58	17.32	18.03	18.71	19.36	20.00	21.21	22.36	23.45	24.49	25.50	26.46	27.39
25	0.125	3.18	0.88	1.25	1.77	2.17	2.50	3.95	6.25	8.84	10.83	12.50	13.98	15.31	16.54	17.68	18.54	19.76	20.73	21.65	22.53	23.39	24.21	25.00	26.52	27.95	29.32	30.62	31.87	33.07	34.23
30	0.141	3.58	1.06	1.50	2.12	2.60	3.00	4.74	7.50	10.61	12.99	15.00	16.77	18.37	19.84	21.21	22.25	23.72	24.87	25.98	27.04	28.06	29.05	30.00	31.82	33.54	35.18	36.74	38.24	39.69	41.08
35	0.152	3.86	1.24	1.75	2.47	3.03	3.50	5.53	8.75	12.37	15.16	17.50	19.57	21.43	23.15	24.75	25.96	27.67	29.02	30.31	31.55	32.74	33.89	35.00	37.12	39.13	41.04	42.87	44.62	46.30	47.93
40	0.156	3.96	1.41	2.00	2.83	3.46	4.00	6.32	10.00	14.14	17.32	20.00	22.36	24.49	26.46	28.28	29.66	31.62	33.17	34.64	36.06	37.42	38.73	40.00	42.43	44.72	46.90	48.99	50.99	52.92	54.77
45	0.172	4.37	1.59	2.25	3.18	3.90	4.50	7.12	11.25	15.91	19.49	22.50	25.16	27.56	29.76	31.82	33.37	35.58	37.31	38.97	40.56	42.09	43.57	45.00	47.73	50.31	52.77	55.11	57.36	59.53	61.62
50	0.177	4.57	1.77	2.50	3.54	4.33	5.00	7.91	12.50	17.68	21.65	25.00	27.95	30.62	33.07	35.36	37.08	39.53	41.46	43.30	45.07	46.77	48.41	50.00	53.03	55.90	58.63	61.24	63.74	66.14	68.47
55	0.179	4.55	1.94	2.75	3.89	4.76	5.50	8.70	13.75	19.45	23.82	27.50	30.75	33.68	36.38	38.89	40.79	43.48	45.60	47.63	49.58	51.45	53.25	55.00	58.34	61.49	64.49	67.36	70.11	72.76	75.31
60	0.188	4.78	2.12	3.00	4.24	5.20	6.00	9.49	15.00	21.21	25.98	30.00	33.54	36.74	39.69	42.43	44.50	47.43	49.75	51.96	54.08	56.12	58.09	60.00	63.64	67.08	70.36	73.48	76.49	79.37	82.16
70	0.281	7.14	2.47	3.50	4.95	6.06	7.00	11.07	17.50	24.75	30.31	35.00	39.13	42.87	46.30	49.50	51.91	55.34	58.04	60.62	63.10	65.48	67.78	70.00	74.25	78.26	82.08	85.73	89.23	92.60	95.85
80	0.297	7.54	2.83	4.00	5.66	6.93	8.00	12.65	20.00	28.28	34.64	40.00	44.72	48.99	52.92	56.57	59.33	63.25	66.33	69.28	72.11	74.83	77.46	80.00	84.85	89.44	93.81	97.98	101.98	105.83	109.54
90	0.316	8.03	3.18	4.50	6.36	7.79	9.00	14.23	22.50	31.82	38.97	45.00	50.31	55.11	59.53	63.64	66.75	71.15	74.62	77.94	81.12	84.19	87.14	90.00	95.46	100.62	105.53	110.23	114.73	119.06	123.24
105	0.335	8.50	3.71	5.25	7.42	9.09	10.50	16.60	26.25	37.12	45.47	52.50	58.70	64.30	69.45	74.25	77.87	83.01	87.06	90.93	94.65	98.22	101.67	105.00	111.37	117.39	123.12	128.60	133.85	138.90	143.78

QUICK CONNECT - 1/4 | 1/8 NOZZLES

Ordering Info: Part No. + Spray Angle + Orifice Size = Ex. PWQC1502				
Part No.	Connection	Spray Angle	Orifice Size	Material
PWQC	Quick Connect	0°, 15°, 25°, 40°	02 to 09	Hardened SS insert in a SS body
PW1/4M	1/4" NPT-M			
PW1/4W	1/4" NPT-F			
PW1/8M	1/8" NPT-M			

- 5,000 PSI Max Pressure
- GPM based on Orifice Size
* See Nozzle Chart on PG 15 *



QUICK CONNECT PACKAGED NOZZLES

Part No.	Connection	Orifice Size
NOZPKG035	Quick Connect	035
NOZPKG04		04
NOZPKG045		045
NOZPKG05		05
NOZPKG055		055
NOZPKG06		06

- 4,000 PSI Max Pressure
- 5 pack contains 1 of each
- 0° (red), 15° (yellow), 25° (green), 40° (white), Soap 65° (black)



1/4" WASHJET NOZZLES - LARGE ORIFICE

Ordering Info: Part No. + Spray Angle + Orifice Size = Ex. PW1/4MH2512				
Part No.	Connection	Spray Angle	Orifice Size	Material
PW1/4MH	1/4" NPT-M	0°, 05°, 15°, 25°, 40°, 65°	10, 12, 15, 20, 30	Hardened SS insert in a SS body

- 4,000 PSI Max Pressure
- GPM based on Orifice Size
* See Nozzle Chart on PG 17 *



1/8" Up To 2" SPRAY NOZZLES

Ordering Info: Connection. + Orifice Type + Spray Angle + Orifice Size = Ex. 1/8VVJB2501				
Connection	Orifice Type	Spray Angle	Orifice Size	Material
1/8" up to 2"	VVJB	0° to 110°	Small Capacity up to Orifice Size 095	Brass
	VVSJB			303 SS
	UJB	Large Capacity Orifice Size 10+	Brass	
	USJB		303 SS	

- 500 PSI Max Pressure
- GPM based on Orifice Size
* See Nozzle Chart on PG 17 *

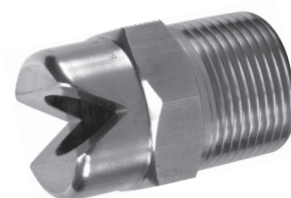

CHEMICAL SOAP NOZZLES

Part No.	Connection	Spray Angle	Orifice Size	Material
PWCH1/4M1550SS	1/4" NPT-M	15°	50	SS
PWCHQC1550	QC			
PWCH1/4M6540	1/4" NPT-M	65°	40	Brass
PWCHQC6540	QC			
PWCH1/8M6540	1/8" NPT-M	25°	40	Brass
PWCH1/4M2540	1/4" NPT-M			
PWCHQC2540	QC			



NOZZLES

HIGH PRESSURE NOZZLES, VARIABLE NOZZLES & HOLDERS

HL280 VARIABLE NOZZLES

Part No.	Orifice Size
HL280	02, 025, 03, 035, 04, 045, 05, 055, 06, 09, 12

- 4,050 PSI Max Pressure
- 8.0 GPM Max Flow
- 195°F Max Temperature
- 1/4" BSP-F Inlet
- 8.5 oz Weight
- High-Low Pressure Setting



VARIOJET NOZZLES

Part No.	Orifice Size (add to Part No.)
VARJET	1.40, 1.45

- 3,000 PSI Max Pressure
- 5.5 GPM Max Flow
- 284°F Max Temperature
- 1/4" BSP-F Inlet
- 3.2 oz Weight
- Spray Angle 0° - 80°



MULTIREG NOZZLES

Part No.	Orifice Size (add to Part No.)
MREG991.	1.35, 1.40, 1.45, 1.50, 1.55

- 3,000 PSI Max Pressure
- 5.5 GPM Max Flow
- 140°F Max Temperature
- 1/4" BSP-F Inlet
- 8.0 oz Weight
- Spray Angle 0° - 80°



VARIOJET & MULTIREG ORIFICE SIZE DETAILS

Orifice Size	Colour	Replacement Orifice
1.35 (035)	Dark Blue	98663200I
1.40 (04)	Red	98667400I
1.45 (045)	Yellow	98669000I
1.50 (05)	Light Blue	98672500I
1.55 (055)	White	98675600I

ASN ADJUSTABLE NOZZLE HOLDER

Part No.
ASN

- 3,600 PSI Max Pressure
- 8.0 GPM Max Flow
- 320°F Max Temperature
- 1/4" NPT-F Inlet/ Outlet
- Rotation of knob allows water to bypass the tip, activating downstream chemical injection.



ANH3 ADJUSTABLE NOZZLE HOLDER

Part No.
ANH3

- 3,650 PSI Max Pressure
- 8.0 GPM Max Flow
- 320°F Max Temperature
- 1/4" BSP/NPT Inlet/ Outlet
- Rotation of knob allows water to bypass the tip, activating downstream chemical injection.



RSN DOUBLE NOZZLE HOLDER

Part No.
RSN

- 2,900 PSI Max Pressure
- 10.5 GPM Max Flow
- 1/4" BSP-F Inlet
- 1/4" NPT-F Outlet
- Holds two nozzles, one for low pressure soap, one for high pressure rinse..



DNH DOUBLE NOZZLE HOLDER

Part No.
DNH

- 3,000 PSI Max Pressure
- 5.5 GPM Max Flow
- 1/4" BSP-F Inlet
- 1/4" NPT-F Outlet
- Holds two nozzles, one for low pressure soap, one for high pressure rinse.



ROTCLEAN ROTATING NOZZLE

Part No.	Orifice Size
ROTCLEAN	1.40 (04), 1.45 (045)

- 1,500 PSI Max Pressure
- 320°F Max Temperature
- 1/4" BSP-F Inlet
- 8.5 oz Weight



ROTOMAX ROTATING NOZZLE

Part No.	Orifice Size
ROTOMAX	1.40 (04), 1.50 (05), 1.60 (06)

- 3,500 PSI Max Pressure
- 176°F Max Temperature
- 1/4" BSP-F Inlet
- Adjustable Spray Pattern 0° - 15°
- 9.2oz Weight



UR16 ROTATING NOZZLE

Part No.	Orifice Size
UR16	02, 025, 03, 04, 045, 05, 055, 06, 065, 07, 08

- 2,300 PSI Max Pressure
- 435 PSI Min Pressure
- 212°F Max Temperature
- 1/4" BSP-F Inlet
- 14.46 oz Weight



UR20 ROTATING NOZZLE

Part No.	Orifice Size
UR20	02, 03, 035, 04, 045, 05, 055, 06, 065, 07

- 3,000 PSI Max Pressure
- 194°F Max Temperature
- 1/4" NPT-F Inlet
- 11.8 oz Weight



UR25 ROTATING NOZZLE

Part No.	Orifice Size
UR25	03, 035, 04, 045, 05, 055, 06, 065, 07, 08

- 3,650 PSI Max Pressure
- 1,150 PSI Min Pressure
- 212°F Max Temperature
- 1/4" BSP-F Inlet
- 14.46 oz Weight



UR32 ROTATING NOZZLE

Part No.	Orifice Size
UR32	03, 035, 04, 045, 05, 055, 06, 065, 07, 08

- 5,100 PSI Max Pressure
- 2,600 PSI Min Pressure
- 212°F Max Temperature
- 1/4" NPT-F Inlet
- 14.46 oz Weight



UR35 ROTATING NOZZLE

Part No.	Orifice Size
UR35	02, 03, 035, 04, 045, 05, 055, 06, 065, 08, 09, 10, 12, 20

- 5,000 PSI Max Pressure
- 194°F Max Temperature
- 1/4" NPT-F Inlet
- 25.5 oz Weight



UR40 ROTATING NOZZLE

Part No.	Orifice Size
UR40	03, 035, 04, 045, 05, 055, 06, 07, 08, 10, 12

- 5,800 PSI Max Pressure
- 2,600 PSI Min Pressure
- 140°F Max Temperature
- 1/4" Inlet
- Brass Construction
- Low Vibration Nozzle
- 15.6 oz Weight



UR50 ROTATING NOZZLE

Part No.	Orifice Size
UR50	04, 045, 05, 055, 06, 065, 07

- 7,250 PSI Max Pressure
- 194°F Max Temperature
- 1/4" BSP-F Inlet
- 21.0 oz Weight



UR70 ROTATING NOZZLE

Part No.	Orifice Size
UR70	03, 035, 04, 05, 06, 065, 07, 08

- 10, 150 PSI Max Pressure
- 2,600 PSI Min Pressure
- 140°F Max Temperature
- 1/4" Inlet
- Stainless Steel Construction
- Seat/ Nozzle orifice in Tungsten Carbide
- 24.4 oz Weight

Stainless Steel

Tungsten Carbide



URHX ROTATING NOZZLE

Part No.	Orifice Size
URHX2	08, 10, 12

- 3,000 PSI Max Pressure
- 1,000 PSI Min Pressure
- 180°F Max Temperature
- 1/2" NPT-F Inlet
- Nozzle & Seat - Tungsten Carbide
- Nozzle Body - 303 Stainless Steel
- High Density Polyethylene Coated
- Integrated Inlet Mesh Filter
- Low Vibration Nozzle
- 17.6 oz Weight

Stainless Steel

Tungsten Carbide



NOZZLES

SANDBLASTING NOZZLES

QC - HP INLINE FILTERS

Part No.	Connection
GP100622 (SS)	1/4" NPT-M x 1/4" NPT-M
GP100647 (Brass)	1/4" NPT-F x 1/4" NPT-M
GP100560 (Brass)	1/4" QC x 1/4" NPT-M

- 5,000 PSI Max Pressure
- 8.0 GPM Max Flow
- 200°F Max Temperature
- 100 Mesh SS Screen



SBH - SANDBLASTING HEAD

Part No.	Nozzle Size
SBH0	1.50 mm
SBH1	1.60 mm
SBH2	1.70 mm
SBH3	1.85 mm
SBH4	2.10 mm
SBH5	2.30 mm

- 1,000 to 3,000 PSI Max Pressure
- 2.1 to 13.2 GPM Max Flow
- 1/4" BSP-F Inlet
- 9.0 oz Tungsten Carbide Nozzle
- 95 to 177 lbs HR Sand Requirement
- Sand Poker 107047011



SBK5500 - SANDBLASTING KIT

Part No.
SBK5500

- 5,500 PSI Max Pressure
- 8.0 GPM Max Flow
- 1/4" BSP-F Inlet
- Tungsten Carbide Nozzle
- Includes 21" Steel Probe & 25' Suction Hose with 1/4" QC
- PW1/4M Not Included



ADJUSTABLE PROBES FOR TS8 & TS12

Part No.	Inlet
25030000P	13 mm
25030020P	21 mm

- 25030000P for TS8250
- 25030020P for SBHS80012
- Length 19.7"
- 21.5 oz - 25030000P
- 23.35 oz - 25030020P



TS8250 - SANDBLASTING KIT

Part No.	Nozzle Size
TS8250	04

- 3,650 PSI Max Pressure
- 10.5 GPM Max Flow
- 195°F Max Temperature
- 1/4" BSP-F Inlet
- Tungsten Carbide Nozzle
- Includes Sandpoker



TS12 - SANDBLASTING HEAD

Part No.
SBHS80012

- 7,250 PSI Max Pressure
- 21.0 GPM Max Flow
- 195°F Max Temperature
- 1/4" BSP-F Inlet, 1/4" NPT Connector
- 31.4 oz Weight
- Tempered Nickel Galvanized Steel Body with Conveyor in Tungsten Carbide
- Nozzle Not Included



A42R - SELF-PROPELLED

Part No.	Max Flow
25518020P	5.3 GPM
25518030P	5.3 - 8.0 GPM
25518040P	8.0 - 10.5 GPM

- 2,000 PSI Max Pressure
- 580 PSI Min Pressure
- 195°F Max Temperature
- 1/2" BSP-F Inlet
- Nozzle Type 3 x 1/8" NPT-M (Not Included)
- 3.39" (86 mm) min. Overall Coverage



A42R360 - 3600 SELF-PROPELLED

Part No.	Max Flow
25536015P	4.5 GPM

- 2,000 PSI Max Pressure
- 580 PSI Min Pressure
- 195°F Max Temperature
- 1/2" BSP-F Inlet
- Nozzle Type 4 x 1/8" NPT-M (Not Included)
- 4.25" (108 mm) min. Overall Coverage
- Models available up to 13.2 GPM. Call for more details.



AR80 - SELF-PROPELLED

Part No.	Max Flow
25482020P	51.5 GPM
25482025P	6.6 GPM
25482030P	8.0 GPM
25482040P	10.6 GPM
25482050P	13.2 GPM
25482060P	16.0 GPM
25482070P	18.5 GPM
25482080P	22.5 GPM
25482090P	31.7 GPM
25482200P	Optional Protection Cage

- 2,000 PSI Max Pressure
- 435 PSI Min Pressure
- 6.6 - 31.7 GPM Max Flow
- 195°F Max Temperature
- 3/4" BSP-F Inlet
- 303 Stainless Steel
- Nozzle Type 4 x 1/4" NPT-M (Not Included)
- 6.4" (165 mm) min. Overall Coverage

Stainless Steel



A300R - HIGH VOLUME SELF-PROPELLED

Part No.	Max Flow
25600010P	26.45 GPM
25600015P	34.36 GPM
25600017P	38.86 GPM
25600020P	46.63 GPM
25600024P	57.0 GPM
25600030P	79.3 GPM

- 1,015 PSI Max Pressure
- 435 PSI Min Pressure
- 26.45 - 79.3 GPM Max Flow
- 195°F Max Temperature
- 1-1/4" BSP-F Inlet
- 303 Stainless Steel
- Nozzle Type 4 x 1/4" NPT-M (Not Included)
- 7.19" (183 mm) min. Overall Coverage

Stainless Steel



M21E - ELECTRIC BARREL CLEANER

Part No.	Length	Voltage
25430000P	21.7"	230VAC

- 3,200 PSI Max Pressure
- 5.5 GPM Max Flow
- 195°F Max Temperature
- AR1A-M22 Inlet
- Nozzle Type 2 x M4 (Included)
- 1.57" (40 mm) min. Overall Coverage



MI63 - HYDRAULIC TANK CLEANER

Part No.	Length
25460024P	36"

- 2,000 PSI Max Pressure
- 435 PSI Min Pressure
- 13.2 GPM Max Flow
- 195°F Max Temperature
- 3/4" BSP-F Inlet
- Nozzle Type 4 x M4 (Not Included)
- 1.8" (45 mm) min. Overall Coverage



M63E - ELECTRIC 24VAC TANK CLEANER

Part No.	Length
25450004P	36"

- 2,000 PSI Max Pressure
- 580 PSI Min Pressure
- 13.2 GPM Max Flow
- 195°F Max Temperature
- 3/8" BSP-F Inlet
- Nozzle Type 4 x M4 (Not Included)
- 1.8" (45 mm) min. Overall Coverage



M63P - AIR DRIVEN TANK CLEANER

Part No.	Length
25452004P	36"
25452604P	25.6"

- 2,000 PSI Max Pressure
- 580 PSI Min Pressure
- 13.2 GPM Max Flow
- 195°F Max Temperature
- 3/8" BSP-F Inlet
- Nozzle Type 4 x M4 (Not Included)
- 1.8" (45 mm) min. Overall Coverage



NOZZLES

DRAIN CLEANING NOZZLES

JT - NON-ROTATING BALL TYPE JETTING NOZZLE

Part No.	Length	OD	* Orifice Size	Jet Position Foreward - Back
JT1/8*	1/8"	.59	035, 050, 055, 060, 065, 075, 10, 12	1 - 3
JT1/8NF*	1/4"	.75	035, 040, 045, 060, 090	0 - 3
JT1/4*	1/4"	.75	040, 045, 055, 080, 090, 10, 12	1 - 3
JT1/4*	1/4"	.75	060, 075, 11	1 - 4
JT1/4*	1/4"	.75	11	1 - 5
JT1/4NF*	1/4"	.75	035, 040, 045, 050, 055, 060, 090, 12	0 - 3
JT3/8*	3/8"	.92	055, 085	1 - 3
JT3/8*	3/8"	.92	040, 12, 14, 15, 20	1 - 4
JT3/8*	3/8"	.92	070	0 - 4

■ 4,200 PSI Max Pressure



JTI - NON-ROTATING BALL TYPE JETTING NOZZLE WITH INSERT

Part No.	Length	OD	* Orifice Size	Jet Position Foreward - Back
JTI1/4*	1/4"	.98"	060, 080, 10, 12, 15, 20	1 - 6
JTI1/4NF*	1/4"	.98"	060, 080, 10, 12, 15, 20	0 - 6
JTI3/8*	3/8"	1.18"	060, 080, 10, 12, 15, 20	1 - 4
JTI3/8NF*	3/8"	1.18"	060, 080, 10, 12, 15, 20	0 - 4
JTI3/8C*	3/8"	.98"	060, 080, 10, 12, 15, 20	1 - 6
JTI3/8CNF*	3/8"	.98"	060, 080, 10, 12, 15, 20	0 - 6
JTI1/2*	1/2"	1.18"	060, 080, 10, 12, 15, 20	1 - 6
JTI1/2NF*	1/2"	1.18"	060, 080, 10, 12, 15, 20	0 - 6
JTI3/4*	3/4"	2.76"	40	1 - 6
JTI3/4NF*	3/4"	2.76"	40	0 - 6
JTI1*	1"	2.95"	75	1 - 6
JTI1NF*	1"	2.95"	75	0 - 6

■ 7,250 PSI Max Pressure



ZDRAI - DRAIN CLEANING NOZZLES

Part No.	Pressure	Inlet
ZDRAIREG (Adjustable Flow)	3,000 PSI	3/8" BSP-M
ZDRAIMIN	3,500 PSI	1/8" BSP-F
ZDRAIMIN2	3,500 PSI	



JTR - ROTATING JETTING NOZZLES

Part No.	Length	OD	* Orifice Size	Jet Position Foreward - Back
JTR1/8*	1/8"	.74	045, 05, 055, 06, 07, 08	0 - 3 - 0
JTR1/4*	1/4"	.74	04, 045, 05, 055, 06, 07, 08	0 - 3 - 0
JTR1/4S*	1/4"	.74	055, 09	0 - 0 - 2
JTR1/4S*	1/4"	.74	12	3 - 2 - 3
JTR3/8*	3/8"	.94	04, 045, 05, 06, 08, 10, 12, 15, 20	0 - 3 - 0
JTR3/8F*	3/8"	.94	10, 12, 15, 18	1 - 3 - 0

■ 4,000 PSI Max Pressure



CONSUMER HOSES

Part No.	Pressure	Length	Description
HKI2	1,600 PSI	26'	Formula100, Turbo21
984021001	1,000 PSI	26'	Kodiak4000R
HW30516	3,500 PSI	30'	5/16" Connections



JETTING HOSES

Part No.	Pressure	Length
HW501/4JET	4,400 PSI	50'
HW1001/4JET		100'
HW1501/4JET		150''
HW2001/4JET		200'



- 160°F Max Temperature
- 2.5 GPM Max Flow
- Textile Braided Reinforcement
- Black Abrasion Resistant Cover
- 1/4" NPT-M x 1/4" NPT-M Swivel Outlet

BLUE 4000PSI HOSES

Part No.	Pressure	Length
HWN15BLU	4,000 PSI	15'
HWN20BLU		20'
HWN25BLU		25'
HWN30BLU		30'
HWN50BLU		50'
HWN75BLU		75'
HWN100BLU		100'
HWN150BLU		150'
HWN200BLU		200'



- 250°F Max Temperature
- Inlet 3/8" NPT Male Solid
- Outlet 3/8" NPT Male Swivel
- Steel Wire Single Braid
- Smooth Wrap
- 3:1 Burst Ratio
- Inner Diameter 3/8"
- Outer Diameter .68"
- Minimum Bend Radius 5"
- Bend Restrictors (6" length)

BLUE 4000PSI HOSES

Part No.	Pressure	Length
HWN301/4BLU	4,000 PSI	30'
HWN501/4BLU		50'
HWN1001/4BLU		100'
HWN1501/4BLU		150'
HWN40001/4BLUBULK		300'



- 250°F Max Temperature
- Inlet 1/4" NPT Male Solid
- Outlet 1/4" NPT Male Swivel
- Steel Wire Braid
- Bulk hose has no fittings or spool

GREY 6000PSI HOSES

Part No.	Pressure	Length
HWN506000GR	6,000 PSI	50'
HWN756000GR		75'
HWN1006000GR		100'
HWN1506000GR		150'
HWN2006000GR		200'



- 250°F Max Temperature
- Inlet 3/8" NPT Male Solid
- Outlet 3/8" NPT Male Swivel
- Steel Wire Braid
- Smooth Wrap
- 3:1 Burst Ratio
- Inner Diameter 3/8"
- Outer Diameter .68"
- Minimum Bend Radius 5"
- Bend Restrictors (6" length)

BLACK 4000PSI HOSES

Part No.	Pressure	Length
HWN5CPQU	4,000 PSI	5'
HWN15		15'
HWN25		25'
HWN30		30'
HWN50		50'
HWN75		75'
HWN100		100'
HWN150		150'
HWN200		200'



- 250°F Max Temperature
- Inlet 3/8" NPT Male Solid
- Outlet 3/8" NPT Male Swivel
- Steel Wire Single Braid
- Smooth Wrap
- 3:1 Burst Ratio
- Inner Diameter 3/8"
- Outer Diameter .68"
- Minimum Bend Radius 5"
- Bend Restrictors (6" length)

BLACK 6000PSI HOSES

Part No.	Pressure	Length
HWN506000	6,000 PSI	50'
HWN1006000		100'



- 250°F Max Temperature
- Inlet 3/8" NPT Male Solid
- Outlet 3/8" NPT Male Swivel
- Steel Wire Braid
- Smooth Wrap
- Inner Diameter 3/8"
- 3:1 Burst Ratio
- Outer Diameter .68"
- Minimum Bend Radius 5"
- Bend Restrictors (6" length)

BULK HOSES - NO SPOOL/ FITTINGS

Part No.	Pressure	Colour	Length
HWN4000BULK	4,000 PSI	Black	300'
HWN4000BLBULK		Blue	
HWN6000BK BULK	6,000 PSI	Black	
HWN6000GR BULK		Grey	

- 250°F Max Temperature
- Inlet 3/8" NPT Male Solid
- Outlet 3/8" NPT Male Swivel
- Steel Wire Braid
- Smooth Wrap
- 3:1 Burst Ratio
- Inner Diameter 3/8"
- Outer Diameter .68"
- Minimum Bend Radius 5"
- Bend Restrictors (6" length)
- Steel Wire Single Braid (4,000 PSI)
- Steel Wire Double Braid (6,000 PSI)

HOSE REELS

MANUAL AND POWER HOSE REELS

ECONOMICAL HOSE REEL

Part No.	Capacity	ID
HR50NR	50'	3/8"
HR100NR	100'	
HR150NR	150'	
HR200NR	200'	

- 4,000 PSI Max Pressure
- 212°F Max Temperature
- 3/8" NPT-M Inlet
- 3/8" NPT-F Outlet



ECONOMICAL STAINLESS STEEL HOSE REEL

Part No.	Capacity	ID
HR100SS	100'	3/8"
HR150SS	150'	

- 5,000 PSI Max Pressure
- 212°F Max Temperature
- 3/8" NPT-F Inlet
- 3/8" NPT-M Outlet

Stainless Steel



HR65SR - ECONOMICAL SPRING REWIND

Part No.	Capacity	ID
HR65SR	65'	3/8"

- 4,000 PSI Max Pressure
- 210°F Max Temperature
- 3/8" NPT-F Inlet
- 3/8" NPT-M Outlet
- Includes a black 65' 4,000 PSI High Pressure Hose



ECONOMICAL SPRING REWIND HOSE REEL

Part No.	Capacity	ID
HR5800SR	65'	3/8"

- 5,800 PSI Max Pressure
- 212°F Max Temperature
- 3/8" NPT-F Inlet
- 3/8" NPT-M Outlet



NEW!

PW2 & PWK400 WALL MOUNT KIT & HR4KIT

Part No.	Capacity	ID
PW2	150'	3/8"
PWK400	Wall Mount Kit	
HR4KIT	PW Hose Reel Kit - 150' Cap.	

- 4,000 PSI Max Pressure
- 400°F Max Temperature
- 3/8" NPT-F Inlet
- 3/8" NPT-F Outlet



DYNA HEAVY DUTY 'A' FRAME HOSE REEL

Part No.	Capacity	ID
DYNA50150	150'	3/8"
DYNA50300	300'	

- 5,000 PSI Max Pressure
- 250°F Max Temperature
- 1/2" NPT-F Inlet
- 1/2" NPT-M Outlet
- Stainless Steel Construction



NEW!

HANNAY SERIES 1000 & 1000SS HOSE REEL

Part No.	Capacity	ID
10141416*	75'	1/4" - 3/8"
10161416*	100'	
10201416*	150'	

*Add SS to Part No to specify Stainless Steel

- 5,000 PSI Max Pressure
- 212°F Max Temperature
- 3/8" NPT-F Inlet/Outlet



1500 SERIES - MANUAL OR POWER HOSE REEL

Part No.	Capacity	ID
15141718	75'	3/8"
15201718	175'	
15261718	300'	
15301718	375'	
15361718	475'	

- 3,000 PSI Max Pressure
- 400°F Max Temperature
- 1/2" NPT-F Inlet/Outlet
- Handles Hose ID 1/4" up to 5/8"
- Specify Voltage for Power Hose Reel
 - E1 2V - 12 Volt No Switch
 - E2 4V - 24 Volt No Switch
 - E1 15V - 115 Volt No Switch



6000 SERIES - MANUAL OR POWER HOSE REEL

Part No.	Capacity	ID
60241921	200'	1/2"
60321921	350'	1/2"
60242324	400'	1/2"
60302324	225'	3/4"
60382324	300'	3/4"
60162526	250'	1/2"
60222526	450'	1/2"
60282526	275'	3/4"
60183031	400'	1/2"
60243031	350'	3/4"
60283031	450'	3/4"

- 2,000 PSI Rated Pressure
- 250°F Max Temperature
- 1" NPT-F Inlet/Outlet
- Specify Voltage for Power Hose Reel
 - EP12V - 12 volt with Switch and Solenoid
 - EP24V - 24 volt with Switch and Solenoid
 - E115V - 115 volt with Switch and Solenoid
 - HD - Hydraulic
 - A - Air



N700 - SPRING REWIND

Part No.	Capacity	ID
N71614168C	25'	3/8"
N7161617CSR	35'	3/8"
N7161920J	50'	3/8"
N7162324J	65'	3/8"
N7162324G	100'	1/2"
N7162526B	75'	3/8"
N7182526G	100'	3/8"
718302120D	150'	3/8"

- 3,000 PSI Rated Pressure
- 250°F Max Temperature
- 1/2" NPT-F Inlet/Outlet



RAMEX - SPRING REWIND

Part No.	Capacity	ID
HR1000FEH	50'	1/4", 3/8",
HR3500FEH	115'	1/2"

- 3,500 PSI Max Pressure
- 280°F Max Temperature
- 1/2" M Inlet
- 1/2" F Outlet
- Powder Coated Steel
- Hose Bumper Included



RAMEX - STAINLESS STEEL SPRING REWIND

Part No.	Capacity	ID
HR1000H	50'	1/4", 3/8",
HR3500H	115'	1/2"

- 3,500 PSI Max Pressure
- 280°F Max Temperature
- 1/2" M Inlet
- 1/2" F Outlet
- 304 Stainless Steel
- Hose Bumper Included

Stainless Steel



RAMEX - STAINLESS STEEL SPRING REWIND

Part No.	Capacity	ID
HR3501	3/4" up to 66' 1" up to 43'	3/4", 1"

- 1,500 PSI Max Pressure
- 212°F Max Temperature
- 1" M Inlet
- 3/4" F Outlet
- 304 Stainless Steel
- Hose Bumper Included

Stainless Steel



BKKIT - BRAKE KIT

- Optional Slow Retraction Safety Device
- For Use With All RAMEX Spring Rewind Hose Reels

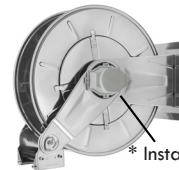

* Installed Brake Kit



RAMEX - MANUAL REWIND

Part No.	Capacity	ID
AVM9817FE	3/4" up to 82' 1" up to 66'	3/8", 1"

- 1,500 PSI Max Pressure
- 212°F Max Temperature
- 1" M Inlet
- 3/4" F Outlet
- Powder Coated Steel



RAMEX - STAINLESS STEEL MANUAL REWIND

Part No.	Capacity	ID
HR9817	3/4" up to 82' 1" up to 66'	3/8", 1"

- 1,500 PSI Max Pressure
- 212°F Max Temperature
- 1" M Outlet
- 3/4" F Inlet
- 304 Stainless Steel

Stainless Steel



RAMEX STAINLESS STEEL 'A' FRAME HOSE REEL

Part No.	Capacity	ID
AVM9811AF	3/8" up to 115' 1/2" up to 98'	3/8" & 1/2"

- 3,625 PSI Max Pressure
- 284°F Max Temperature
- 1/2" M Inlet
- 1/2" F w/ Adapter - 3/8" NPT Outlet
- 304 Stainless Steel construction
- 303 Stainless Steel Swivel



NOTE:
Other Hose Reels
available.
Please contact us for
more details.

QUICK CONNECT FITTINGS

BALL TYPE QC FITTINGS

QC SOCKETS - BRASS

Part No.	Pressure	Connection
QC7214	4,000 PSI	1/4" NPT-F
QC7210		1/4" NPT-M
QC7218		3/8" NPT-F
QC7217		3/8" NPT-M
QC7235		1/2" NPT-F
QC7230		1/2" NPT-M

- 212°F Max Temperature
- EPDM O-Rings



QC SOCKETS - STAINLESS STEEL

Part No.	Pressure	Connection
QDSS250F	4,500 PSI	1/4" NPT-F
QDSS250M		1/4" NPT-M
QDSS375F		3/8" NPT-F
QDSS375M		3/8" NPT-M
QDSS500F		1/2" NPT-F
QDSS500M		1/2" NPT-M

- 212°F Max Temperature
- EPDM O-Rings
- 304 Stainless Steel

Stainless Steel



QC PLUG - ZINC PLATED HARDENED STEEL

Part No.	Pressure	Connection
QC7193	4,000 PSI	1/4" NPT-F
QC7194		1/4" NPT-M
QC7195		3/8" NPT-F
QC7196		3/8" NPT-M

- 212°F Max Temperature
- EPDM O-Rings

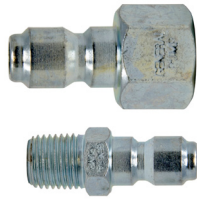

QC PLUG - STAINLESS STEEL

Part No.	Pressure	Connection
PLSS250F	4,500 PSI	1/4" NPT-F
PLSS250M		1/4" NPT-M
PLSS375F		3/8" NPT-F
PLSS375M		3/8" NPT-M
QC7191		1/2" NPT-F
QC7190		1/2" NPT-M

- 212°F Max Temperature
- 304 Stainless Steel

Stainless Steel



10,000 PSI PLUG AND QC FITTING

Part No.	Pressure	Connection
PL500-10SS	Plug	1/2" QC
PC500-10SS	QC Fitting w/ locking feature	

- 10,000 PSI Max Pressure
- 250°F Max Temperature
- 1/2" NPT-F Inlet
- 1/2" NPT-M Outlet



EGQC EASY GRIP - BRASS

Part No.	Pressure	Connection
EGQC250F	4,000 PSI	1/4" NPT-F
EGQC250M		1/4" NPT-M
EGQC375F		3/8" NPT-F
EGQC375M		3/8" NPT-M

- 212°F Max Temperature
- EPDM O-Ring



REPLACEMENT O-RINGS

Part No.	Size	Material
QC7109D13	1/4"	EPDM
QC7109D14	3/8"	EPDM
QC7109D37	1/2"	EPDM
QC7109D26	1/4"	Viton
QC7109D40	3/8"	Viton
QC7109D42	1/2"	Viton



AR25 - PA LONG PLUG & SOCKET

Part No.	Connection
26245051P	Part A Plug x 1/4" BSP-F
26241060P	Part B Socket x 1/4" BSP-M

- 3,650 PSI Max Pressure
- 10.5 GPM Max Flow
- 320°F Max Temperature

Features:

- Quick Accessory Change
- Snug Fit - No Wobbling

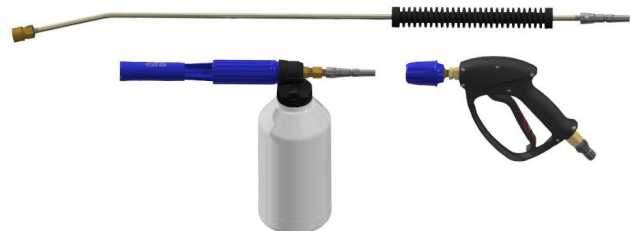

QCA - INTERPUMP SCREW PLUG

Part No.	Connection
QCA250M	M22-14 x 1/4" BSP-M
QCA250F	M22-14 x 1/4" BSP-F
QCA375M	M22-14 x 3/8" BSP-M
QCA375F	M22-14 x 3/8" BSP-F

- 3,000 PSI Max Pressure
- 10.5 GPM Max Flow
- 284°F Max Temperature
- Screw Type QC Part A
- Brass



QCB - INTERPUMP SCREW CONNECTOR

Part No.	Connection
QCB250M	M22-14 x 1/4" BSP-M
QCB250F	M22-14 x 1/4" BSP-F
QCB375M	M22-14 x 3/8" BSP-M
QCB375F	M22-14 x 3/8" BSP-F

- 3,000 PSI Max Pressure
- 10.5 GPM Max Flow
- 284°F Max Temperature
- Screw Type QC Part B
- Brass

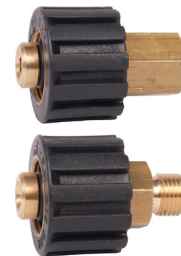

AR1A - PA SCREW PLUG

Part No.	Connection
AR1AM250	M22-14 x 1/4" BSP-M
AR1AF250	M22-14 x 1/4" BSP-F
AR1AM375	M22-14 x 3/8" BSP-M
AR1AF375	M22-14 x 3/8" BSP-F
AR1AM500	M22-14 x 1/2" BSP-M
AR1AF500	M22-14 x 1/2" BSP-F

- 3,650 PSI Max Pressure
- 10.5 GPM Max Flow
- 320°F Max Temperature
- Screw Type QC Part A
- Brass



AR1B - PA SCREW CONNECTOR

Part No.	Connection
AR1BM250	M22-14 x 1/4" BSP-M
AR1BF250	M22-14 x 1/4" BSP-F
AR1BM375	M22-14 x 3/8" BSP-M
AR1BF375	M22-14 x 3/8" BSP-F
AR1BM500	M22-14 x 1/2" BSP-M
AR1BF500	M22-14 x 1/2" BSP-F

- 3,650 PSI Max Pressure
- 10.5 GPM Max Flow
- 320°F Max Temperature
- Screw Type QC Part B
- Brass

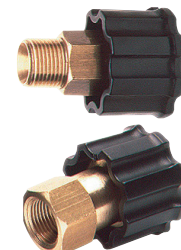

AR41 - PA SS SCREW CONNECTOR

Part No.	Connection
AR41A	M22-14 Part A x 3/8" BSP-F
AR41B	M22-14 Part B x 3/8" BSP-F

- 3,650 PSI Max Pressure
- 10.5 GPM Max Flow
- 320°F Max Temperature
- 303 Stainless Steel

Stainless Steel

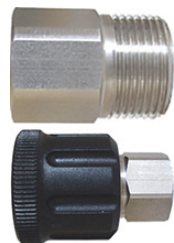

AR8 - PA SCREW CONNECTOR

Part No.	Connection
26063040P	M24-14 Part A x 3/8" BSP-F
26065050P	M24-14 Part B x 3/8" BSP-F

- 5,100 PSI Max Pressure
- 8.0 GPM Max Flow
- 320°F Max Temperature
- Brass

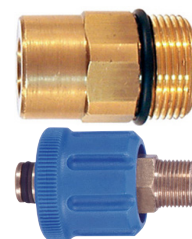

AR9 - PA SCREW CONNECTOR

Part No.	Connection
26094070P	M24-1 4 Part A x 1/2" BSP M
26095070P	M24-1 4 Part B x 1/2" BSP M

- 8,700 PSI Max Pressure
- 21.0 GPM Max Flow
- 320°F Max Temperature
- 303 Stainless Steel

Stainless Steel

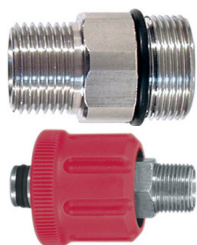

SW7010/7016 FOAMING BRUSH SWIVELS

Part No.	Connection
SW7010	3/8" NPT-M x 3/8"
SW7016	1/2" NPT-M x 1/2"

- For Low Pressure Operation
- Brass Construction



26100010P LIGHT DUTY SWIVELS

Part No.	Connection
26100010P	3/8" NPT-M x 3/8" NPT-F

- 3,650 Max Pressure
- 8.0 GPM Max Flow
- 194°F Rated Temperature
- Brass Construction



SW7080/7480 HIGH PRESSURE SWIVELS

Part No.	Connection
SW7480	1/4" NPT-M x 1/4" NPT-F
SW7080	3/8" NPT-M x 3/8" NPT-F

- 3,000 PSI Max Pressure
- 200°F Max Temperature
- Brass Construction with SS Insert



SW7044/7470 HIGH PRESSURE SWIVELS

Part No.	Connection
SW7470	1/4" NPT-M x 1/4" NPT-F
SW7044	3/8" NPT-M x 3/8" NPT-F

- 5,000 PSI Max Pressure
- 10 GPM Max Flow
- 200°F Max Temperature
- Stainless Steel

Stainless Steel



SW3500BR HIGH PRESSURE SWIVELS

Part No.	Connection
SW3500BR	3/8" BSP-M x 3/8" BSP-F

- 3,650 PSI Max Pressure
- 10.5 GPM Max Flow
- 194°F Rated Temperature
- Brass Construction

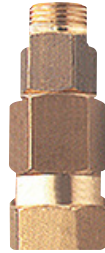

SW5114/3500 HIGH PRESSURE SWIVELS

Part No.	Connection
SW5114	1/4" BSP-M x 1/4" BSP-F
SW3500	3/8" BSP-M x 3/8" BSP-F

- 5,100 PSI Max Pressure
- 10.5 GPM Max Flow
- 194°F Max Temperature
- Stainless Steel

Stainless Steel



SW25 SERIES

Part No.	Connection
26120020P	1/4" BSP-M x 1/4" BSP-F
26120040P	3/8" BSP-M x 3/8" BSP-F

- 3,650 PSI Max Pressure
- 10.5 GPM Max Flow
- 194°F Rated Temperature
- Nickel Plated Brass/SS Ball Bearing



SW600 HIGH PRESSURE SWIVELS

Part No.	Connection
SW600	3/8" BSP-F x 3/8" BSP-F

- 8,700 PSI Max Pressure
- 15.8 GPM Max Flow
- 194°F Max Temperature
- Stainless Steel

Stainless Steel



SW7035 90° BOOM SWIVELS

Part No.	Connection
SW7035	3/8" NPT-F x 3/8" NPT-F

- 3,000 PSI Max Pressure
- 10.0 GPM Max Flow
- 200°F Max Temperature
- Stainless Steel/Viton O-rings

Stainless Steel



SW7475 90° HOSE REEL SWIVELS

Part No.	Connection
SW7475	1/2" NPT-F x 1/2" NPT-F

- 3,000 PSI Max Pressure
- 10.0 GPM Max Flow
- 300°F Max Temperature
- Brass Construction/Viton O-rings

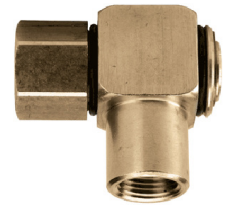

SW9014/9038 90° HIGH PRESSURE SWIVELS

Part No.	Connection
SW9014	1/4" BSP-M x 1/4" BSP-F
SW9038	3/8" BSP-M x 3/8" BSP-F

- 3,650 PSI Max Pressure
- 10.5 GPM Max Flow
- 194°F Rated Temperature
- Stainless Steel

Stainless Steel

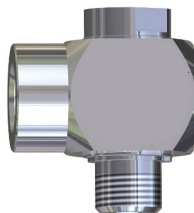

SW9012 90° HIGH PRESSURE SWIVELS

Part No.	Connection
SW9012	1/2" BSP-M x 1/2" BSP-F

- 5,100 PSI Max Pressure
- 21.0 GPM Max Flow
- 194°F Max Temperature
- Stainless Steel

Stainless Steel

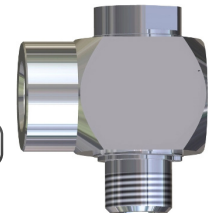

GLYCERIN FILLED BOTTOM MOUNT

Part No.	Pressure Range
025FF00030WT	0 to 30 PSI
025FF00060WT	0 to 60 PSI
025FF00100WT	0 to 100 PSI
025FF00160WT	0 to 160 PSI
025FF00200WT	0 to 200 PSI
025FF00300WT	0 to 300 PSI
025FF00500WT	0 to 500 PSI
025FF00600WT	0 to 600 PSI

- 2-1/2" Diameter
- 1/4" NPT-M Bottom Connection

Part No.	Pressure Range
025FF01000WT	0 to 1000 PSI
025FF01500WT	0 to 1500 PSI
025FF02000WT	0 to 2000 PSI
025FF03000WT	0 to 3000 PSI
025FF04000WT	0 to 4000 PSI
025FF05000WT	0 to 5000 PSI
025FF06000WT	0 to 6000 PSI
025FF10000WT	0 to 10000 PSI

- Brass Internals
- Glycerin Filled



GLYCERIN FILLED BACK MOUNT

Part No.	Pressure Range
025FFBC00030WT	0 to 30 PSI
025FFBC00060WT	0 to 60 PSI
025FFBC00100WT	0 to 100 PSI
025FFBC00160WT	0 to 160 PSI
025FFBC00200WT	0 to 200 PSI
025FFBC00300WT	0 to 300 PSI
025FFBC00600WT	0 to 600 PSI

- 2-1/2" Diameter
- 1/4" NPT-M Back Connection

Part No.	Pressure Range
025FFBC01000WT	0 to 1000 PSI
025FFBC01500WT	0 to 1500 PSI
025FFBC02000WT	0 to 2000 PSI
025FFBC03000WT	0 to 3000 PSI
025FFBC05000WT	0 to 5000 PSI
025FFBC06000WT	0 to 6000 PSI
025FFBC10000WT	0 to 10000 PSI

- Brass Internals
- Glycerin Filled



DRY GAUGES BOTTOM MOUNT

Part No.	Pressure Range
AG25100WT	0 to 100 PSI

- 2-1/2" Diameter
- 1/4" NPT-M Bottom Connection

Part No.	Pressure Range
AG25160WT	0 to 160 PSI

- Brass Internals
- Glycerin Filled



1/8" GAUGES BACK MOUNT

Part No.	Pressure Range
125FFBC03000WT	0 to 3,000 PSI

- 1-1/2" Diameter
- 1/8" NPT-M Back Connection

Part No.	Pressure Range
125FFBC05000WT	0 to 5,000 PSI

- Brass Internals
- Glycerin Filled



INTERPUMP GAUGE VALVE CAP

Part No.	Description
GP190029	For 47 Series
GP190031	For TT Series

- For Installing Pressure Gauges on Interpump Pumps

Part No.	Description
GP190107	For 44 and 63 Series

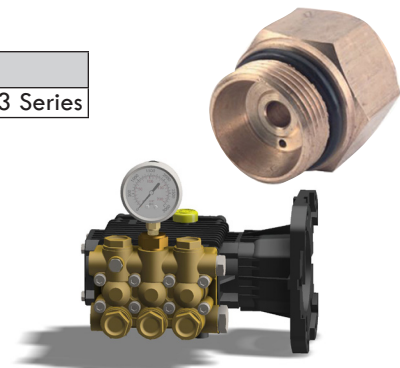

PULSATION DAMPENERS

PDH

Part No.	Inlet	Flow	Volume
PDH-3/8	3/8" NPT-F	8.0 GPM	0.03 Gal
PDH	1/2" NPT-F	16.0 GPM	0.92 Gal

- 580 PSI Preset Charge Pressure
- 176°F Max Temperature
- 1.9 lbs, 5.9 lbs Weight



A4X PULSATION DAMPENER

Part No.	Pressure	Flow
A4X	3,050 PSI	16.0 GPM

- 140°F Max Temperature
- 0.1 Gal Volume
- 1/2" BSP-M Connection
- 4.4 lbs Weight

Stainless Steel



A7 PULSATION DAMPENER

Part No.	Pressure	Flow
A7	3,050 PSI	43.0 GPM

- 140°F Max Temperature
- 0.2 Gal Volume
- 1/2" BSP-M Inlets
- 5.8 lbs Weight



A7S PULSATION DAMPENER

Part No.	Pressure	Flow
A7S	5,075 PSI	43.0 GPM

- 140°F Max Temperature
- 0.2 Gal Volume
- 3/4" BSP-M Inlets
- 12.2 lbs Weight



A7X PULSATION DAMPENER

Part No.	Pressure	Flow
A7X	2,150 PSI	43.0 GPM

- 140°F Max Temperature
- 0.19 Gal Volume
- 3/4" BSP-M Connection
- 12.2 lbs Weight

Stainless Steel



A15 PULSATION DAMPENER

Part No.	Pressure	Flow
A15	4,750 PSI	195 GPM

- 140°F Max Temperature
- 0.4 Gal Volume
- 3/4" BSP-M Inlets
- 15.8 lbs Weight



A15X PULSATION DAMPENER

Part No.	Pressure	Flow
A15X	2,150 PSI	195 GPM

- 140°F Max Temperature
- 0.4 Gal Volume
- 3/4" BSP-M Connection
- 12.2 lbs Weight

Stainless Steel



NOTE:
Pulsation Dampeners work best when calibrated to Operating Pressure.



Nitrogen Gas pre-charge service available. Please inquire with our Sales Team.

FLOW SENSITIVE UNLOADERS & BANJO VALVES

K1 UNLOADER

Part No.	Pressure	Flow
K1	3,600 PSI	2.4 - 10.8 GPM

- 140°F Max Temperature
- 3/8" BSP-F Inlet
- 1/2" BSP-M Outlet
- 1/2" BSP-M Bypass
- 2.3 lbs Weight



K5 UNLOADER

Part No.	Pressure	Flow
K50	3,000 PSI	2.1 - 2.9 GPM
K51		2.9 - 4.2 GPM
K52		4.2 - 6.6 GPM
K53		6.6 - 10.8 GPM

- 140°F Max Temperature
- 3/8" BSP-F Inlet, 1/2" BSP-M Outlet
- 1/2" BSP-F - 3/4" BSP-M Bypass
- 2.4 lbs Weight



K7 UNLOADER

Part No.	Pressure	Flow
K70	3,000 PSI	2.1 - 2.9 GPM
K71		2.9 - 4.2 GPM
K72		4.2 - 6.6 GPM
K73		6.6 - 10.8 GPM

- 140°F Max Temperature
- 3/8" BSP-F Inlet/Bypass
- 3/8" BSP-M Outlet
- 4.5 lbs Weight



K9 UNLOADER

Part No.	Pressure	Flow
K9	5800 PSI	3.9 - 13.2 GPM

- 140°F Max Temperature
- 1/2" BSP-F Inlet, 1/2" BSP-M Outlet
- 1/2" BSP-F Bypass
- 10 lbs Weight



PULSAR ZERO UNLOADER

Part No.	Pressure	Flow
60240050P	4,050 PSI	2.4 - 10.5 GPM

- 140°F Rated Temperature
- 3/8" BSP-F Inlet/Outlet
- 3/8" BSP-F Bypass (2)
- 3.8 lbs Weight



VB60/600 ZERO UNLOADER

Part No.	Pressure	Flow
60260025P	3,600 PSI	2.4 - 16.0 GPM
60260040P	5,800 PSI	
60260000P	8,700 PSI	
60265000P	8,700 PSI w/Switch	

- 140°F Rated Temperature
- 1/2" BSP-F Inlet/Outlet
- 1/2" BSP-F Bypass
- 4.7 lbs Weight
- 303 Stainless Steel

Stainless Steel

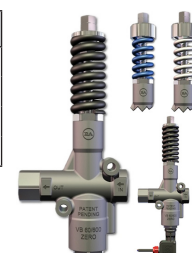

BANJO VALVES

BANJO BOLT TRAPPED PRESSURE UNLOADER

Part No.	Pressure	Flow
60075300P	3,200 PSI	8.0 GPM
60077000P		

- 140° F Rated Temperature
- 3/8" NPT-M Inlet, 3/8" NPT-F Outlet
- 3/8" NPT-F Bypass
- 2.1 lbs Weight
- 60075300P for Comet LW, ZW Series Pumps
- 60077000P for Comet FW, Annovi Reverberi RK Series Pumps



VB135 UNLOADER WITH INJECTOR

Part No.	Pressure	Flow
WP10	2,300 PSI	6.5 GPM

- 140°F Rated Temperature
- 3/8" BSP-F Inlet, 1/4" BSP-F Outlet
- 2.1mm Chemical Injector
- 2.1 lbs Weight
- For 51 Series Interpump



VB56 COMPACT UNLOADER

Part No.	Pressure	Flow
VB56	3,200 PSI	6.5 GPM

- 140°F Rated Temperature
- 1/2" BSP-M Inlet, 3/8" BSP-M Outlet
- 1.3 lbs Weight
- For 44, 47, 50, 60, 63 Series Interpump Pumps



VB75/ VB75INJ UNLOADERS

Part No.	Pressure	Flow
VB75/ VB75INJ	2,300 PSI	6.5 GPM

- *VB75INJ - With Chemical Injector*
- 140°F Rated Temperature
- 1/2" BSP-M Inlet, 3/8" BSP-M Outlet
- 1.3 lbs Weight
- For 44, 47, 50, 63 Series Interpump Pumps



VALVES

BANJO UNLOADER & TRAPPED PRESSURE UNLOADERS

W2 SERIES UNLOADERS

Part No.	Pressure	Flow
W21/W21L	3,000 PSI	2.9 - 4.0 GPM
W22/W22L		4.2 - 5.5 GPM

- 140°F Max Temperature
- 1/2" BSP-M Inlet
- 3/8" BSP-M Outlet
- 3.3 lbs Weight
- W21, W22 for 44 Series Pumps
- W21L, W22L for 47 Series Pumps



SM SERIES UNLOADERS

Part No.	Pressure	Flow
SM0	4,500 PSI	1.6 - 3.7 GPM
SM1		3.7 - 5.55 GPM

- 140°F Max Temperature
- 1/2" BSP-F Inlet, 3/8" BSP-M Outlet
- 1/4" Hose Barb
- 1.6 lbs Weight
- For EVO1, EVO2, EVO3, 44, 47 and 63 Series Pumps



TRAPPED PRESSURE VALVES

HX UNLOADER

Part No.	Pressure	Flow
HX	1,900 PSI	1.3-4.0 GPM

- 140°F Max Temperature
- 3/8" BSP-M Inlet/Outlet
- 3/8" BSP-M Bypass
- 0.5 lbs Weight



VB7 DIRECT MOUNT UNLOADER

Part No.	Pressure	Flow
VB7	3,200 PSI	8.0 GPM

- 140°F Rated Temperature
- 3/8" NPT-M Inlet, 3/8" NPT-F Outlet
- 3/8" NPT-F Bypass
- 1.3 lbs Weight



HM UNLOADER

Part No.	Pressure	Flow
HM	3,000 PSI	1.3-10.8 GPM

- 185°F Max Temperature
- 3/8" BSP-F Inlet
- 3/8" BSP-M, 1/4" BSP-F Outlet
- 3/8" BSP-F Bypass (x2)
- 2.2 lbs Weight



VB8/VB8SW PANEL MOUNT UNLOADER

Part No.	Description
VB8	Plastic Knob, Fitting Nut, 1.5 lbs
VB8SW	Switch, 230 v, 1.8 lbs

- 3,200 PSI Rated Pressure
- 8.0 GPM Max Flow
- 140°F Rated Temperature
- 3/8" NPT-M Inlet, 3/8" NPT-F Outlet
- 3/8" NPT-F Bypass



VB9H PANEL MOUNT UNLOADER

Part No.	Pressure	Flow
VB9H	3,200 PSI	8.0 GPM

- 140°F Rated Temperature
- 3/8" BSP-F Inlet/Outlet
- 3/8" BSP-F Bypass
- 1.7 lbs Weight
- Includes Handle with Panel Fitting



VB350/VB350P UNLOADER

Part No.	Description
VB350	Standard, 2.1 lbs
VB350P	Switch, 250 v, 2.7 lbs

- 5,100 PSI Rated Pressure
- 10.5 GPM Max Flow
- 140°F Rated Temperature
- 3/8" BSP-M Inlet, 3/8" BSP-F Outlet
- 3/8" BSP-F Bypass

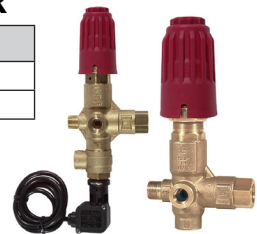

PULSAR 4 UNLOADER

Part No.	Pressure	Description
TPU1023	2,300 PSI	White Spring
TPU1023H		White Spring, Handle
TPU1040	4,050 PSI	Blue Spring, 1.7 lbs
TPU1040H		Blue Spring, Handle
TPU1040HES		Blue Spring, Handle, Easy Start Valve
TPU1040HSW		Blue Spring, Handle, Micro Switch, 2 lbs

- 10.5 GPM Max Flow
- 140°F Rated Temperature
- 3/8" NPT-F Inlet/Outlet
- 3/8" NPT-F Bypass (2)
- Larger internal passages for increased flow



VB80 UNLOADER

Part No.	Pressure	Material
VB80/150SSV	2,200 PSI	303 Stainless Steel
VB80/150-316SSV		316 Stainless Steel
VB80/280SSV	4,050 PSI	303 Stainless Steel
VB80/280-316SSV		316 Stainless Steel
VB80/400SSV	5,800 PSI	303 Stainless Steel

- 21.0 GPM Max Flow
- 140°F Rated Temperature
- 1/2" BSP-F Inlet/Outlet/Bypass
- Viton O-Rings
- 2.5 lbs Weight

Stainless Steel

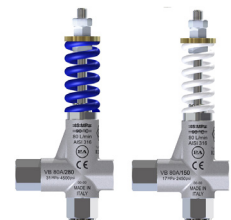

VB85/VB85H UNLOADER

Part No.	Rated Pressure	Description
UTP2123R	2,300 PSI	White Spring
UTP2123HR		White Spring, Handle
UTP2140R	4,050 PSI	Blue Spring
UTP2140HR		Blue Spring, Handle

- 21.0 GPM Max Flow
- 140°F Rated Temperature
- 1/2" NPT-F Inlet/Outlet/Bypass
- Brass Material
- 2.5 lbs Weight

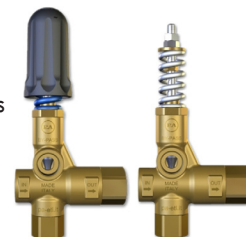

VB33/VB36 UNLOADER

Part No.	Rated Pressure	Rated Temperature
VB33	4,050 PSI	140°F
VBHT33		185°F
VB36	5,100 PSI	145°F
VBHT36		185°F

- 21.0 GPM Max Flow
- 1/2" NPT-F Inlet/Outlet/Bypass
- VB33 w/Black Handle
- VB36 w/Red Handle
- 2.0 lbs Weight



VB80/280SS + VB80/400SS UNLOADER

Part No.	Pressure	Flow
VB80/150SS	2,200 PSI	21.0 GPM
VB80/280SS	4,050 PSI	21.0 GPM
UVS3050	5,800 PSI	21.0 GPM

- 140°F Rated Temperature
- 1/2" NPT-F Inlet/Outlet
- 1/2" NPT-F Bypass
- 2.7 lbs Weight
- 303 Stainless Steel

Stainless Steel



VB43/VB53 UNLOADER

Part No.	Pressure	Flow
VB43/303SS	5,800 PSI	21.0 GPM
VB53/303SS	7,250 PSI	21.0 GPM

- 140°F Rated Temperature
- 1/2" BSP-F Inlet/Outlet
- 1/2" BSP-F Bypass
- 1.9 lbs Weight
- 303 Stainless Steel

Stainless Steel



VB26 UNLOADER

Part No.	Pressure	Flow
VB26	4,050 PSI	21.0 GPM

- 140°F Rated Temperature
- 1/2" BSP-F Inlet/Outlet
- 1/2" BSP-F Bypass
- 1.88 lbs Weight
- 316 Stainless Steel
- Multi-Gun

Stainless Steel



BH210 UNLOADER

Part No.	Pressure	Flow
BH210	3,045 PSI	2.6-29.0 GPM

- 185°F Max Temperature
- 1/2" BSP-F Inlet/Outlet
- 3/4" BSP-F Bypass
- 4.3 lbs Weight



VB200/VB150 UNLOADER

Part No.	Pressure	Flow
60502000P	2,200 PSI	53.0 GPM
60430000P	4,050 PSI	53.0 GPM

- 140°F Rated Temperature
- 1" NPT-F Inlet/Outlet
- 1" NPT-F Bypass
- 4.7 lbs Weight

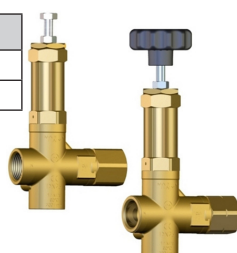

VB450 LARGE FLOW UNLOADER

Part No.	Pressure	Flow
VB450/200	2,900 PSI	120 GPM
VB450/300	4,350 PSI	120 GPM

- 140°F Rated Temperature
- 1-1/4" BSP-F Inlet/Outlet
- 1-1/2" BSP-F Bypass
- 13.5 lbs Weight



AG6815 - REGULATING VALVE

Part No.	Rated Pressure	Inlet-Pipe Connection	Materials of Construction
AG68151/250	50 PSI	1/2"	Brass
AG68151/2300	300 PSI	1/2"	
AG68151/2700	700 PSI	1/2"	
AG68153/450	50 PSI	3/4"	
AG68153/4300	300 PSI	3/4"	
AG68153/4700	700 PSI	3/4"	
AG68151/2HS1200	1,200 PSI	1/2"	Brass with Hardened Stainless Steel Seat
AG68153/4HS700	700 PSI	3/4"	
AG68153/4HS1200	1,200 PSI	3/4"	

- Operates in any Position
- Adjustable
- Extra Wide Passages Handles Full Fluid
- Pressure Setting Locks Into Place
- Free Floating Seat for Overall Speed and Sensitivity of Valve Action



- Pressure regulating valves are used to regulate pressure & protect the system when the discharge is closed.
- Multiple outlets in applications where more than one outlet is required a constant system pressure is maintained.
- System working pressure is maintained regardless of what percentage of fluid is bypassed.

TIMAX REGULATING VALVE

Part No.	Pressure	Flow
TIMAX	900 PSI	52.8 GPM

- 140°F Max Temperature
- 3/4" BSP-F Inlet
- 1/2" BSP-F Outlet (x3)
- 1" BSP-F Bypass
- 3.7 lbs Weight



VRP450 REGULATING VALVE

Part No.	Pressure	Flow
VRP450/200	2,900 PSI	120 GPM
VRP450/300	4,350 PSI	120 GPM

- 140°F Max Temperature
- 1-1/4" BSP-F Inlet/Outlet
- 1-1/2" BSP-F Bypass
- 13.2 lbs Weight



R1 REGULATING VALVE

Part No.	Pressure	Flow
R1/200	2,900 PSI	29 GPM
R1/400	5,800 PSI	29 GPM
R1/600	8,700 PSI	18.5 GPM

- 185°F Max Temperature
- 3/4" BSP-F Inlet
- 3/4" BSP-F Bypass
- 5.5 lbs Weight



R2 REGULATING VALVE

Part No.	Pressure	Flow
R2	3,045 PSI	61 GPM

- 185°F Max Temperature
- 1" BSP-F Inlet
- 3/4" BSP-F Outlet
- 1-1/4" BSP-F Bypass
- 9.9 lbs Weight



R3LP REGULATING VALVE

Part No.	Pressure	Flow
R3LP	3,336 PSI	132 GPM

- 185°F Max Temperature
- 1-1/4" BSP-F Inlet
- 1-1/4" BSP-F Outlet
- 1-1/4" BSP-F Bypass
- 13.2 lbs Weight



R3HP REGULATING VALVE

Part No.	Pressure	Flow
R3HP	6,527 PSI	90 GPM

- 185°F Max Temperature
- 1" BSP-F Inlet
- 1" BSP-F Bypass
- 11.7 lbs Weight



R1503 REGULATING VALVE

Part No.	Pressure	Flow
R1503	21,755 PSI	7.9 GPM

- 104°F Max Temperature
- 6 mm Diameter Inlet
- 1/2" BSP-F Outlet
- 1/2" BSP-M Bypass
- 14.3 lbs Weight
- For VFH, VKH, SMH14 Pump Series

420 SS



R1510 REGULATING VALVE

Part No.	Pressure	Flow
R1510	21,755 PSI	26.4 GPM

- 104°F Max Temperature
- 14 mm Diameter Inlet
- 1/2" BSP-F Outlet
- 3/4" BSP-M Bypass
- 22 lbs Weight
- For SMH, SKH Pump Series

420 SS



R1520 REGULATING VALVE

Part No.	Pressure	Flow
R1520	21,755 PSI	63 GPM

- 104°F Max Temperature
- 19 mm Diameter Inlet
- 1" BSP-F Outlet
- 3/4" BSP-M Bypass
- 20 lbs Weight
- For SRhp, TRhp Pump Series

420 SS



- Safety relief valves are designed to protect a pump or system when its maximum pressure has been exceeded.
- Safety relief valves must never be used in place of pressure regulator or unloader valves.
- Safety relief valves must be selected for maximum system flow rate.

VS30 SAFETY RELIEF VALVE

Part No.	Pressure	Flow
VS30	500 PSI	3.7 GPM

- 140°F Rated Temperature
- 1/4" BSP-M Inlet
- 1/8" BSP-F Bypass
- 3 lbs Weight



VS100 SAFETY RELIEF VALVE

Part No.	Pressure	Flow
VS100	1,813 PSI	5.3 GPM

- 195°F Rated Temperature
- 1/4" BSP-F Inlet/Bypass
- 316 Stainless Steel, Viton O-Rings
- 2.5 lbs Weight

316 SS



VS170 SAFETY RELIEF VALVE

Part No.	Pressure	Flow
VS170	2,200 PSI	6.3 GPM

- 140°F Rated Temperature
- 3/8" BSP-F Inlet
- 3/8" BSP-F Bypass
- 0.75 lbs Weight



VS28 SAFETY RELIEF VALVE

Part No.	Pressure	Flow GPM
VS28-1	1,450 PSI	2.1-3.2
VS28-2	to	3.2-4.2
VS28-3	3,650 PSI	4.2-5.15

- 226°F Rated Temperature
- 1/4" NPT-M Inlet, 5/8" Barb
- 0.123 lbs Weight



VS220 SAFETY RELIEF VALVE

Part No.	Pressure	Flow
VS220	3,200 PSI	6.3 GPM

- 140°F Rated Temperature
- 3/8" BSP-F Inlet (x2)
- 3/8" BSP-F Bypass
- 0.9 lbs Weight

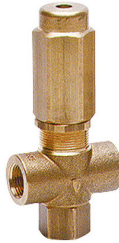

VS240 SAFETY RELIEF VALVE

Part No.	Pressure	Flow
VS240	3,500 PSI	6.3 GPM

- 140°F Rated Temperature
- 3/8" NPT-M Inlet
- Delrin Ball Action Type
- 0.3 lbs Weight



SRI SAFETY RELIEF VALVE

Part No.	Pressure	Flow
SRI	3,000 PSI	1.3-10.8 GPM

- 165°F Rated Temperature
- 3/8" BSP-M Inlet
- 1/4" BSP-F Outlet
- 1 lbs Weight



GP100726 SAFETY RELIEF VALVE

Part No.	Pressure	Flow
GP100726	6,000 PSI	6.0 GPM

- 150°F Rated Temperature
- 3/8" NPT-M Inlet
- Side Discharge
- 1 lbs Weight



VS350 SAFETY RELIEF VALVE

Part No.	Pressure	Flow
VS350	5,100 PSI	6.5 GPM

- 140°F Rated Temperature
- 2 x 3/8" BSP-F Inlet
- 3/8" BSP-F Bypass
- 1 lbs Weight



VS310 SAFETY RELIEF VALVE

Part No.	Pressure	Flow
VS310	4,500 PSI	10.5 GPM

- 140°F Rated Temperature
- 3/8" BSP-F Inlet
- 3/8" BSP-F Outlet
- 0.837 lbs Weight

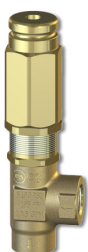

VS26 SAFETY RELIEF VALVE

Part No.	Pressure	Material
VS26	4,050 PSI	316 SS, Viton Seals

- 21 GPM
- 140°F Rated Temperature
- 1/2" BSP-F Inlet/Bypass
- 2 lbs Weight

Stainless Steel



VS500 HP SAFETY RELIEF VALVE

Part No.	Pressure	Flow
60520000P	7,250 PSI	21.0 GPM
60523000P	4,500 PSI	

- 140°F Rated Temperature
- 1/2" BSP-F Inlet
- 3/8" BSP-F Bypass
- 3.13 lbs Weight



VS200/180 SAFETY RELIEF VALVE

Part No.	Pressure	Flow
VS200/180	2,600 PSI	53 GPM
VS200/180SP w/Locking Cap		

- 140°F Rated Temperature
- 3/4" NPT-F Inlet
- 1/2" NPT-F Bypass
- 1.8 lbs Weight

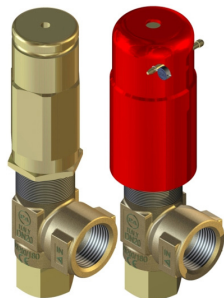

VS23 SAFETY RELIEF VALVE

Part No.	Pressure	Flow
VS23-14	2,030 PSI	18.5 GPM
VS23-15	2,175 PSI	
VS23-20	2,900 PSI	
VS23-22	3,190 PSI	
VS23-25	3,625 PSI	
VS23-28	4,060 PSI	

- 140°F Rated Temperature
- 1/2" BSP-F Inlet/Outlet
- 2 lbs Weight

Duplex SS



VS450 LARGE FLOW SAFETY RELIEF VALVE

Part No.	Pressure	Flow
VS450/200	2,900 PSI	120 GPM
VS450/300	4,350 PSI	

- 140°F Rated Temperature
- 1-1/4" NPT-F Inlet/Outlet
- 8.75 lbs Weight



VS660 SAFETY RELIEF VALVE

Part No.	Pressure	Flow
VS660	9,500 PSI	16 GPM
VS660H w/ Locking Cap		

- 140°F Rated Temperature
- 3/8" BSP-F Inlet/Bypass
- 1.2 lbs Weight

303 SS

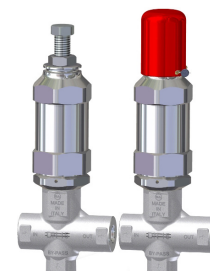

S455 SAFETY RELIEF VALVE

Part No.	Pressure	Flow
S455/170	2,465 PSI	132 GPM
S455/200	2,900 PSI	
S455/300	4,350 PSI	
S455/400	5,800 PSI	

- 185°F Rated Temperature
- 3/4" BSP-M Inlet
- For pump models MW, MK2, ML2S, LK, MF
- 7.2 lbs Weight



S723 SAFETY RELIEF VALVE

Part No.	Pressure	Flow
S723-100	1,450 PSI	61 GPM
S723-200	2,900 PSI	
S723-300	4,350 PSI	
S723-400	5,800 PSI	
S723-500	7,250 PSI	
S723-600	8,700 PSI	
S723-700	1,0150 PSI	

- 185°F Rated Temperature
- 1/2" BSP-M Inlet
- For pump models KE, KT, KF, HF, KS, MW, MK2, MK2S
- 3.8 lbs Weight



S1503 SAFETY RELIEF VALVE

Part No.	Pressure	Flow
S1503	21,750 PSI	7.9 GPM

- 104°F Rated Temperature
- 1/2" BSP-M Inlet
- For pump models VFH, VKH, SMH14
- 6 lbs Weight



S1510 SAFETY RELIEF VALVE

Part No.	Pressure	Flow
S1510	21,750 PSI	26.4 GPM

- 104°F Rated Temperature
- 1/2" BSP-M Inlet
- For pump models SMH, SKH
- 6 lbs Weight



S1520 SAFETY RELIEF VALVE

Part No.	Pressure	Flow
S1520	21,750 PSI	63 GPM

- 104°F Rated Temperature
- 1" BSP-M Inlet
- For pump models SRhp, TRhp
- 17.8 lbs Weight

300 SS



S4090 SAFETY RELIEF VALVE

Part No.	Pressure	Flow
S4090	5,800 PSI	251 GPM

- 104°F Rated Temperature
- 1/2" BSP-M Inlet
- For pump models SRIp, TRIp
- 45 lbs Weight

300 SS



RP80/500 PNEUMATIC GUN

Part No.	Pressure	Flow
RP80/500	7,250 PSI	21 GPM

- 140°F Rated Temperature
- 1/2" BSP-F Inlet/Outlet
- 101 PSI Air Pressure
- 1/4" BSP-F Air Ports
- 5.8 lbs Weight



RP30/RP120 PNEUMATIC GUN

Part No.	Pressure	Flow
RP30	2,300 PSI	8 GPM
RP280	4,050 PSI	32 GPM

- 140°F Rated Temperature
- 1/4" BSP-F Inlet, 3/8" BSP-F Outlet
- 101 PSI Air Pressure
- 1/4" BSP-F Air Ports
- 1.2 lbs Weight



PNR2 PNEUMATIC REGULATOR

Part No.	Pressure	Flow
PNR2	3,045 PSI	5.2-61 GPM

- 185°F Max Temperature
- 1" BSP-F Inlet, 1/4" BSP-F Outlet
- 1-1/4" BSP-F Bypass
- 116 PSI Air Pressure
- 1/4" BSP-F Air Ports
- 10.3 lbs Weight
- Used on KE, KT, KF, KS & MW



PNRA2 PNEUMATIC UNLOADER

Part No.	Pressure	Flow
PNRA2	3,045 PSI	5.2-61 GPM

- 185°F Max Temperature
- 1" BSP-F Inlet, 3/4" BSP-F Outlet
- 1-1/4" BSP-F Bypass
- 116 PSI Air Pressure
- 1/4" BSP-F Air Ports
- 11 lbs Weight
- Used on KT, KF & KS



PN2 PNEUMATIC VALVE

Part No.	Pressure	Flow
PN2-140	2,030 PSI	61 GPM
PN2-250	3,626 PSI	61 GPM
PN2-500	7,250 PSI	61 GPM

- 140°F Max Temperature
- 1" BSP-F Inlet/Outlet/Bypass
- 95 PSI Air Pressure
- 1/4" BSP-F Air Ports
- 35.2 lbs Weight
- Used on KE, KT, KF, KS & MW



PN4 PNEUMATIC VALVE

Part No.	Pressure	Flow
PN4-200	2,900 PSI	132 GPM
PN4-300	4,350 PSI	103 GPM
PN4-450	6,530 PSI	69 GPM

- 140°F Max Temperature
- 1-1/2" BSP-F Inlet/Outlet/Bypass
- 101 PSI Air Pressure
- 1/4" BSP-F Air Ports
- 35 lbs Weight
- Used on MW, MK2, MKS2 & LK



PNR1503 PNEUMATIC VALVE

Part No.	Pressure	Flow
PNR1503	21,755 PSI	7.9 GPM

- 104°F Max Temperature
- 13.2 lbs Weight
- Used on VFH, VKH & SMH14



PNR1510 PNEUMATIC VALVE

Part No.	Pressure	Flow
PNR1510	21,750 PSI	24 GPM

- 140°F Max Temperature
- 14 mm Inlet, 1/2" BSP-F Outlet
- 3/4" BSP-F Bypass
- 145 PSI Air Pressure
- 1/4" BSP-F Air Ports
- 29.7 lbs Weight
- Used on SMH & SKH



PNR1520 PNEUMATIC VALVE

Part No.	Pressure	Flow
PNR1520	21,750 PSI	63 GPM

- 86°F Max Temperature
- 19 mm Inlet, 1" BSP-F Outlet
- 1-1/4" BSP-F Bypass
- 145 PSI Air Pressure
- 1/4" BSP-F Air Ports
- 29.7 lbs Weight
- Used on SRhp & TRhp



PNR4090 PNEUMATIC VALVE

Part No.	Pressure	Flow
PNR4090	21,755 PSI	24.4 GPM

- 104°F Max Temperature
- 29.7 lbs Weight
- Used on SRlp & TRlp



VRPP170 AIR CONTROLLED VALVE

Part No.	Pressure	Flow
VRPP170	2,200 PSI	53.0 GPM

- 140°F Rated Temperature
- 1" BSP-F Inlet/Outlet
- 87 PSI Air Pressure
- 1/4" BSP-F Air Ports
- 8.83 lbs Weight



VRPP26 AIR CONTROLLED VALVE

Part No.	Pressure	Flow
VRPP26	4,050 PSI	21 GPM

- 140°F Rated Temperature
- 1/2" BSP-F Inlet/Outlet
- 87 PSI Air Pressure
- 1/4" BSP-F Air Ports
- 8.16 lbs Weight

316 SS



VRPP450 LARGE FLOW VALVE

Part No.	Pressure	Flow
VRPP450/200	2,900 PSI	120 GPM

- 140°F Rated Temperature
- 1-1/4" BSP-F Inlet/Outlet
- 87 PSI Air Pressure
- 1/4" BSP-F Air Ports
- 18.8 lbs Weight



VRPP600 AIR CONTROLLED VALVE

Part No.	Pressure	Flow
VRPP600	8,100 PSI	21 GPM

- 140°F Max Temperature
- 1/2" BSP-F Inlet/Outlet
- 87 PSI Air Pressure
- 1/4" BSP-F Air Ports
- 8.1 lbs Weight

303 SS



BALL VALVES

HIGH PRESSURE STEAM BALL VALVES

Part No.	Connection
HWMPV38	3/8" NPT-F
HWMPV12	1/2" NPT-F

- 3,000 PSI Rated Pressure
- 20-400°F Max Temperature
- Steel Body, Ball and Stem, Full Port
- Carbon/Graphite Filled PTFE Seat and Seals



HIGH PRESSURE VALVES BVCS

Part No.	Connection
BVCS2403-B	1/4" NPT-F, Full Port
BVCS2403-C	3/8" NPT-F, Full Port
BVCS2403-D	1/2" NPT-F, Full Port
BVCS2403-E	3/4" NPT-F, Full Port
BVCS2403-H	1" NPT-F, Full Port
BVCS2403-J	1-1/4" NPT-F, Standard Port
BVCS2403-K	1-1/2" NPT-F, Standard Port
BVCS2403-M	2" NPT-F, Standard Port

- 5,075-7,250 PSI Rated Pressure
- -22°F to +212°F Temperature
- 3-Piece Design
- Carbon Steel



10 SERIES - 2-PIECE THREADED BALL VALVE

Part No.	NPT	Torque	Weight
10S-4	1/4"	31 in-lb	0.5 lb
10S-6	3/8"	35.4 in-lb	0.5 lb
10S-8	1/2"	48.7 in-lb	0.7 lb
10S-12	3/4"	66.4 in-lb	1 lb
10S-16	1"	97.4 in-lb	1.7 lb
10S-20	1-1/4"	132.8 in-lb	2.5 lb
10S-24	1-1/2"	177 in-lb	3.9 lb
10S-32	2"	354 in-lb	5.9 lb

- Full Port, 1/4" - 2"
- W.P.: 1,000 PSI
- W.T.: -4°F to 392°F
- Investment Casting
- Blow-Out Proof Stem
- Locking Device
- Thread Type: NPT
- CRN Registered



20 SERIES - 2-PIECE THREADED BALL VALVE

Part No.	NPT	Torque	Weight
20S-4	1/4"	36 in-lb	0.6 lb
20S-6	3/8"	36 in-lb	0.6 lb
20S-8	1/2"	39 in-lb	0.7 lb
20S-12	3/4"	52 in-lb	1.2 lb
20S-16	1"	65.1 in-lb	1.9 lb

- Full Port, 1/4" - 1"
- W.P.: 2,000 PSI
- W.T.: -4°F to 392°F
- Investment Casting
- Blow-Out Proof Stem
- Locking Device
- Thread Type: NPT
- CRN Registered



VALVES

THERMAL & CHECK VALVES

VT6 THERMAL VALVE

Part No.	Connection
60063000P	1/4" BSP-M
60063050P	3/8" BSP-M
60063070P	1/2" BSP-M

- 125 PSI Rated Pressure
- 145°F Rated Temperature
- 1/4" Hose Barb
- 1.8 oz Weight

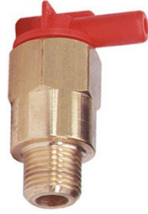

GP100556/557/558 THERMAL VALVE

Part No.	Connection
GP100556	1/4" NPT-M
GP100557	3/8" NPT-M
GP100558	1/2" NPT-M

- 125 PSI Rated Pressure
- 145°F Rated Temperature
- 1/4" Hose Barb (90°)
- 1.5 oz Weight



GP100512/513/514 THERMAL VALVE

Part No.	Connection
GP100512	1/4" NPT-M
GP100513	3/8" NPT-M
GP100514	1/2" NPT-M

- 125 PSI Rated Pressure
- 145°F Rated Temperature
- 2.0 oz Weight



GP100680 THERMAL VALVE

Part No.	Connection
GP100679	3/8" NPT-M
GP100680	1/2" NPT-M

- 90 PSI Rated Pressure
- 190°F Rated Temperature
- 90° Brass Hose Barb
- 1.5 oz Weight



TRV THERMAL VALVE

Part No.	Connection
TRV38-1AG	3/8" NPT-M
TRV50-1AG	1/2" NPT-M

- 145°F Rated Temperature
- Brass Construction
- 2.0 oz Weight



JETTER VALVE

Part No.	For Pump Series
GP100315	Interpump 51, 60 Series
GP100316	Interpump 44, 63, EVO2, EVO3 Series
GP100317	Interpump 47 Series (Coarse Thread)
GP100072	Interpump 47 Series (Fine Thread)
GP101065	Interpump EVO1 Series

- Replaces Valve Cap
- 0.61 lbs Weight



VRNI CHECK VALVE

Part No.	Connection	Flow
60203000P	1/4" BSP-F	6.5 GPM
60202000P	3/8" BSP-F	10.5 GPM
60207000P	1/2" BSP-F	21.0 GPM
60208000P	3/4" BSP-F	47.6 GPM

- 5,800 PSI Rated Pressure
- 190°F Rated Temperature
- 1.9 - 13.1 oz Weight

303 SS



VRNO CHECK VALVE

Part No.	Connection	Flow
VNRO14	1/4" BSP-F	6.5 GPM
VNRO38	3/8" BSP-F	10.5 GPM
VNRO12	1/2" BSP-F	21.0 GPM
VNRO34	3/4" BSP-F	47.6 GPM

- 2,200 PSI Rated Pressure
- 190°F Rated Temperature
- 2.0 - 13.1 oz Weight



EASY START VALVE

Part No.	Connection
ESV	3/8" NPT-M Inlet

- 4,050 PSI Rated Pressure
- 175°F Rated Temperature
- 8 mm Hose Barb Outlet
- 4.9 oz Weight



HIGH PRESSURE SOLENOID VALVE - NORMALLY CLOSED

Part No.	Connection	Seal
DC453P*	3/8" NPT-F	Buna-N
DC458PS*	1" NPT-F	Buna-N
DC453S*	3/8" NPT-F	Buna-N
DC454P*	1/2" NPT-F	Buna-N
DC458P*	1" NPT-F	Buna-N

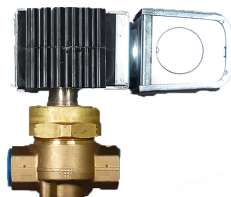

- 1,200 PSI Rated Pressure
- Brass Construction
- Stainless Steel Seats
- DC453P* & DC458PS* w/ Stainless Steel Pistons
- *Specify Voltage: 12, 24, 120, 240

HIGH PRESSURE SOLENOID VALVE - NORMALLY OPENED

Part No.	Connection	Seal
DCO453P*	3/8" NPT-F	Teflon

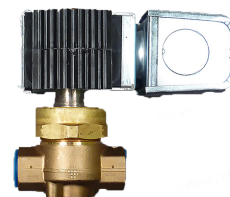

- 1,000 PSI Rated Pressure
- Brass Construction
- Stainless Steel Seats
- *Specify Voltage: 12, 24, 120, 240

PILOT PISTON SOLENOID VALVE - NORMALLY CLOSED

Part No.	Connection	Seal
DC413P*	3/8" NPT-F	Teflon
DC414P*	1/2" NPT-F	Teflon
DC416P*	3/4" NPT-F	Teflon
DC418P*	1" NPT-F	Teflon

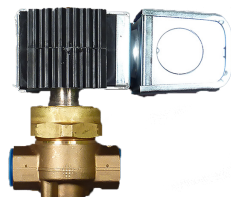

- 150 PSI Rated Pressure
- Brass Construction
- Stainless Steel Seats
- *Specify Voltage: 12, 24, 120, 240

PILOT PISTON SOLENOID VALVE - NORMALLY OPENED

Part No.	Connection	Seal
DCO412P*	3/8" NPT-F	Teflon

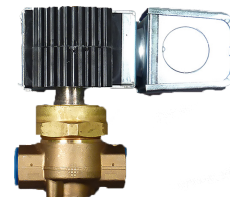

- 150 PSI Rated Pressure
- Brass Construction
- Stainless Steel Seats
- *Specify Voltage: 12, 24, 120, 240

DIAPHRAGM SOLENOID VALVE

Part No.	Connection	Seal
DC473P*	3/8" NPT-F	Buna-N
DC474P*	1/2" NPT-F	Buna-N
DC476P*	3/4" NPT-F	Buna-N

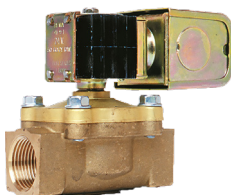

- 150 PSI Rated Pressure
- Brass Material
- *Specify Voltage: 12, 24, 120, 240

DIRECT ACTING SOLENOID VALVE

Part No.	Connection	Seal
DC401P*	1/4" NPT-F	Buna-N
DC424P*	1/4" NPT-F	Buna-N
DC412P*	3/8" NPT-F	Teflon

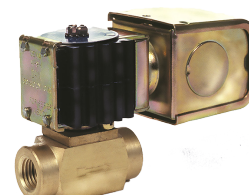

- 150 PSI Rated Pressure
- Normally Closed
- Brass Construction (401 + 412)
- Stainless Steel Construction (424)
- *Specify Voltage: 12, 24, 120, 240

SWITCHES

FLOW SWITCHES

FSI FLOW SWITCH

Part No.	Flow Pump Inlet	Flow Pump Outlet
FSI	0.8 GPM	8 GPM

- 3,650 PSI Max Pressure
- 0.8 GPM Vertical Switching Flow
- 0.8 GPM Horizontal Switching Flow
- 122°F Rated Temperature
- 3/8" BSP-M Connections
- 230VAC, 3.0A



SPEEDMATIC RPM CONTROLLER

Part No.	Connection
SPEEDMATIC	3/8" BSP-M

- 3,000 PSI rated Pressure
- 140°F Max Temperature

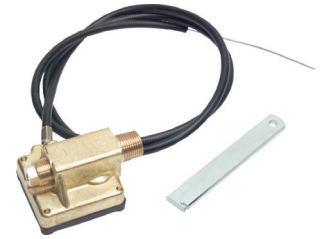

FL7SS FLOW SWITCH

Part No.	Flow Pump Inlet	Flow Pump Outlet
FL7SS	8.0 GPM	16 GPM

- 2.4 GPM Vertical Switching Flow
- 1.6 GPM Horizontal Switching Flow
- 7,300 PSI Rated Pressure
- 165°F Rated Temperature
- 3/8" BSP-F Connections
- 230VAC, 3.0A



FL7N FLOW SWITCH

Part No.	Flow Pump Inlet	Flow Pump Outlet
FL7N	8.0 GPM	16 GPM

- 2.4 GPM Vertical Switching Flow
- 1.6 GPM Horizontal Switching Flow
- 5,100 PSI Rated Pressure
- 165°F Rated Temperature
- 3/8" BSP-F Connections
- 230VAC, 3.0A



FL7MS FLOW SWITCH

Part No.	Flow Pump Inlet	Flow Pump Outlet
FL7MS	8.0 GPM	16 GPM

- 0.1 GPM Vertical Switching Flow
- Horizontal Switching Flow Not Applicable
- 5,100 PSI Rated Pressure
- 165°F Rated Temperature
- 3/8" BSP-F Connections
- 230VAC, 3.0A



FL12 FLOW SWITCH

Part No.	Flow Pump Inlet	Flow Pump Outlet
FL12	13.2 GPM	26.4 GPM

- 4,000 PSI Rated Pressure
- 3.3 GPM Vertical Switch Flow
- 2.0 GPM Horizontal Switch Flow
- 165°F Rated Temperature
- 3/4" NPT-F Connections
- 230 V, 3.0 A



103012PV PHEONIX FLOW SWITCH

Part No.	Flow
103012PV	0.75 - 18.7 GPM
GP103011*	

- 4,000 PSI Max Pressure
- 0.75 GPM Switch Flow
- 190°F Max Temperature
- 3/8" NPT-F Connections
- 24 VDC, 3.0 A - 120 VAC, 0.8 A
- *GP103011 without Pilot Valve

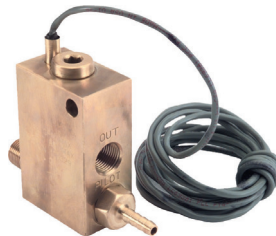

GP100934/953 INLINE FLOW SWITCHES

Part No.	Description
GP100934	Brass - 5000 PSI
GP100953	SS - 5800 PSI

- 12.0 GPM Max Flow
- 1.5 GPM Switch Flow
- 180°F Max Temperature
- 3/8" NPT-F Connections
- 250 V, 5.0 A Micro Switch



GP100879 FLOW SWITCH

Part No.	Flow
GP100879	0.5 - 12 GPM

- 4,000 PSI Max Pressure
- 0.5 GPM Switch Flow
- 180°F Max Temperature
- 3/8" NPT-F Connections
- 250 V, 5.0 A



SQ2/SQ3 LOW PRESSURE SWITCHES

Part No.	Connection	Switching Pressure
SQ2	1/8" NPT-M	6-30 PSI
SQ3	1/8" NPT-M	20-120 PSI

- 250 PSI Rated Pressure
- 140°F Rated Temperature
- 125/250VAC, 10A



SIMPLEX3 PRESSURE SWITCH

Part No.	Connection	Switching Pressure
SIMPLEX3	1/4" BSP-M	435 PSI

- 3,000 PSI Rated Pressure
- 140°F Rated Temperature
- 250VAC, 5A Resistive 1A Inductive



PSW1-15B PRESSURE SWITCH

Part No.	Connection	Switching Pressure
PSW1-15B	1/4" BSP-M	220 PSI

- 3,650 PSI Rated Pressure
- 165°F Rated Temperature
- 250VAC, 16A Resistive 6A Inductive



PR16 PRESSURE SWITCH

Part No.	Connection	Switching Pressure
PSW	3/8" BSP-M	580 PSI
PSW1	1/4" BSP-M	580 PSI

- 3,650 PSI Rated Pressure
- 165°F Rated Temperature
- 250VAC, 16A Resistive 6A Inductive



PR16SS PRESSURE SWITCH

Part No.	Connection	Switching Pressure
PSW1SS	1/4" BSP-M	580 PSI
29003552P	1/4" BSP-M	360 PSI

- 3,650 PSI Rated Pressure
- 165°F Rated Temperature
- 250VAC, 16A Resistive 6A Inductive

303 SS



PR1 PRESSURE SWITCH

Part No.	Connection	Switching Pressure
PSW2	3/8" BSP-M	670 PSI

- 8,700 PSI Rated Pressure
- 165°F Rated Temperature
- 250VAC, 16A Resistive 6A Inductive

303 SS



HIGH LIMIT SWITCHES

Part No.	Connection	Switching Temperature
GP101094	1/2" NPT-M	6-30 PSI
GP101138	1/2" NPT-M	20-120 PSI

- 3,650 PSI Rated Pressure
- 120VAC, 5A



TECHNICAL INFORMATION FOR PSW1, PSW2, PR16 AND PR16SS

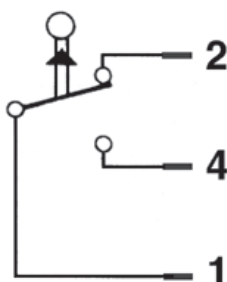

WIRING DIAGRAM

1) Red 2) Blue 4) Brown

ELECTRICAL CONNECTION

N.O. Red + Brown – Normally Opened

N.C. Red + Blue – Normally Closed

CHEMICAL INJECTORS

ADJUSTABLE CHEMICAL INJECTOR

Part No.	QC Inlet/Outlet	Flow
GP100633	3/8" F, 3/8" M	2.0-3.0 GPM
GP100653	3/8" M, 3/8" F	2.0-3.0 GPM
GP100634	3/8" F, 3/8" M	3.0-5.0 GPM
GP100654	3/8" M, 3/8" F	3.0-5.0 GPM
GP100635	3/8" F, 3/8" M	5.0-8.0 GPM
GP100655	3/8" M, 3/8" F	5.0-8.0 GPM



- 3,500 PSI Max Pressure
- 140°F Max Temperature
- 1/4" Hose Barb
- 1.85 mm Nozzle
- 1.8 mm Orifice

ROBOKIM CHEMICAL INJECTOR

Part No.	Nozzle	Flow
CJ0	2.0 mm	2.1-2.9 GPM
CJOB	2.0 mm	2.1-2.9 GPM, Brass Knob
CJ1	2.2 mm	2.9-4.0 GPM
CJ1B	2.2 mm	2.9-4.0 GPM, Brass Knob
CJ2	2.5 mm	4.0-5.6 GPM
CJ2B	2.5 mm	4.0-5.6 GPM, Brass Knob
CJ3	2.75 mm	5.6-10.8 GPM
CJ3B	2.75 mm	5.6-10.8 GPM, Brass Knob

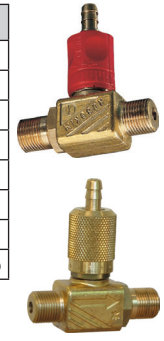

- 3,200 PSI Max Pressure
- 210°F Max Temperature
- 3/8" NPT-M Inlet/Outlet
- 1/4" Hose Barb

ADJUSTABLE BRASS CHEMICAL INJECTOR

Part No.	Nozzle	Flow
AIJ18	1.8 mm	2.11-3.17 GPM
AIJ21	2.1 mm	2.64-3.96 GPM
AIJ23	2.3 mm	3.17-4.76 GPM



- 4,050 PSI Max Pressure
- 195°F Max Temperature
- 3/8" NPT-M Inlet/Outlet
- 7 mm Hose Barb
- Brass

ADJUSTABLE SS CHEMICAL INJECTOR

Part No.	Nozzle	Flow
AIJ18SS	1.8 mm	2.11-3.17 GPM
AIJ21SS	2.1 mm	2.64-3.96 GPM
AIJ23SS	2.3 mm	3.17-4.76 GPM



- 5,100 PSI Max Pressure
- 195°F Max Temperature
- 3/8" NPT-M Inlet/Outlet
- 7 mm Hose Barb
- Stainless Steel w/Teflon O-ring

Stainless Steel

B SERIES LOW PRESSURE INJECTOR

Part No.	Description
DA202B*	1/4" NPT-F
DA203B*	3/8" NPT-F
DA204B*	1/2" NPT-F
DA206B*	3/4" NPT-F, Metering Knob



* Add "T" for Metering Tip Knob

- Up to 700 PSI Max Pressure
- 0.25-60 GPM Max Flow
- 150°F Max Temperature
- 1/4"-3/8" Hose Barb

C SERIES LOW PRESSURE INJECTOR

Part No.	Description
DA2003C*	1/8" NPT
DA200C*	1/8" NPT
DA201C*	1/8" NPT
DA202C*	1/4" NPT
DA203C*	3/8" NPT
DA204C*	1/2" NPT
DA206C*	3/4" NPT
DA208C*	1" NPT



* Add "T" for Metering Tip Knob

- Up to 700 PSI Max Pressure
- .25-100 GPM Max Flow
- 150°F Max Temperature
- 1/4"-3/8" Hose Barb

B SERIES HIGH PRESSURE INJECTOR

Part No.	Description
DA202BS	1/4" NPT-F, SS Metering Knob
DA203BS	3/8" NPT-F, SS Metering Knob
DA204BS	1/2" NPT-F, SS Metering Knob
DA206BS	3/4" NPT-F, SS Metering Knob, Screw
DA203BS2	3/8" NPT-F, Stainless Steel Body
DA204BS2	1/2" NPT-F, Stainless Steel Body
DA203BST2	3/8" NPT-F



- Up to 3,000 PSI Max Pressure
- .25-60 GPM Max Flow
- 150°F Max Temperature
- 1/4"-3/8" Hose Barb

C SERIES HIGH PRESSURE INJECTOR

Part No.	Description
DA2003CS*	1/8" NPT
DA200CS*	1/8" NPT
DA201CS*	1/8" NPT
DA208CS*	1" NPT, Metering Tip



* Add "T" for Metering Tip Knob

- Up to 3,000 PSI Max Pressure
- .25-100 GPM Max Flow
- Up to 150°F Max Temperature
- 1/4"-3/8" Hose Barb

METERING VALVES & PROPORTIONERS

CMV45 CHEMICAL METERING VALVE

Part No.	Hose Barb
CMV45	1/4"

- 400 PSI Max Pressure
- 2.6 GPM Max Flow
- 105°F Max Temperature
- 15 mm Panel Fitting
- 6.2 oz Weight



RD6 TWIN INLET CHEMICAL VALVE

Part No.	Hose Barb
CMSVPA	0.28"

- 7.3 PSI Max Pressure
- 0.26 GPM Max Flow
- 140°F Max Temperature
- 2.19 oz Weight



FLOAT VALVE

Part No.	Inlet
FLV	3/4" BSP-M

- 145 PSI Max Pressure
- 8.0 GPM Max Flow
- 140°F Max Temperature
- 2.75 oz Weight



RD5 CHEMICAL RESTRICTING VALVE

Part No.	Hose Barb
RD5	0.28"

- 400 PSI Max Pressure
- 2.6 GPM Max Flow
- 105°F Max Temperature
- 1/4" BSP-M Inlet
- 7.5 oz Weight



RG30 FLOAT VALVE

Part No.	Inlet
29022000P	3/8" BSP-M
29022020P	1/2" BSP-M
29022070P	3/4" BSP-M

- 145 PSI Max Pressure
- 10.5 GPM Max Flow
- 140°F Max Temperature
- 1/2" Hose Barb
- 3.8 oz Weight



RG6012 & RG6034 FLOAT VALVES

Part No.	Inlet
RG6012	1/2" BSP-M
RG6034	3/4" BSP-M

- 87 PSI Max Pressure
- 11.1 GPM Max Flow @ 14.5 PSI
- 16.0 GPM Max Flow @ 29.0 PSI
- 140°F Max Temperature
- 1/2" Hose Barb
- RG6012-13.83 oz Weight
- RG6034-15.63 oz Weight



FAUCET PROPORTIONERS

Part No.	Description
DA151 KIT	Push Button w/ Tips
DA151LT	Push Button Less Tips
DA153	Push Button w/ Tips & Built in Air Gap
DA154	Push Button w/ Metering Screw & Built in Air Gap
DA167	4 GPM Proportioner w/ Metering Screw
DA167T	4 GPM Proportioner w/ Tip Kit DP10015K

- Multiple Faucet Adapters
- 1/4" ID Barb with 8' Hose
- 140°F Max Temperature



DRUM MOUNT PROPORTIONERS

Part No.	Description
DA161	High Induction Drum Mount Proportioner
DA162	Proportioner w/ Metering Screw Adjustment
DA1623	Proportioner w/ Metering Tip Adjustment
DA163BAG	Proportioner, 4 GPM, w/ Air Gap
DA163H	High Capacity Proportioner w/ Metering Tip Kit
DA164	Proportioner, 1 GPM, w/ Metering Tip Kit
DA164 BAG	Proportioner, 1 GPM, w/ Air Gap

- 2-1/2" Bung Adapters
- Up to 10 GPM Dispensing Rate
- Adjust Mixing Rate



DEMA TIP KITS

Part No.	Description
DP10015K	Dema 1005K Metering Tip Kit for 1/4" Barb
DP619K	Dema 6.19K Metering Tip Kit for 3/8" Barb



DP10015K



DP619K

FML01/LS12 FOAMER LANCE

Part No.	Description
FML01	Brass
LS12SS	Stainless Steel Foamer

- 2,900 PSI Max Pressure
- 6.5 GPM Max Flow
- 140°F Max Temperature
- 1/4" BSP-F Inlet
- 1.5 mm Injector



LS12 FOAMER LANCE WITH EXTERNAL INJECTOR

Part No.	Description
LS12	1.8mm Nozzle
LS12-21	2.1mm nozzle
LS12-25	2.5mm nozzle

- 2,900 PSI Max Pressure
- 6.5 GPM Max Flow
- 140°F Max Temperature
- 1/4" BSP-F Inlet
- External Injector



FML01T/FML02T FOAM LANCE WITH TANK

Part No.	Description
FML01T	Foamer with 1L Tank
FML02T	Foamer with 2L Tank

- 2,900 PSI Max Pressure
- 6.5 GPM Max Flow
- 140°F Max Temperature
- 1/4" BSP-F Inlet
- 1.5 mm Injector
- Replacement 1L tank 14650625P
- Replacement 2L tank 14650700P



LS10BL2 FOAM LANCE WITH TANK

Part No.	Description
LS10BL2	Foamer with 2L Tank

- 2,900 PSI Max Pressure
- 6.5 GPM Max Flow
- 150°F Max Temperature
- 3/8" BSP-M Inlet
- Replacement 2L Tank: 14650700R



LS10BL2KIT FOAM CLEANING KIT

Part No.	Description
LS10BL2KIT	Foam Cleaning Kit

- 2,900 PSI Max Pressure
- 6.5 GPM Max Flow
- 150°F Max Temperature
- 3/8" BSP-M Inlet

LS10BL2KIT includes:

1 x LS10BL2 Foam Lance with Tank, 1 x AMFO203BR Brass Adapter, 1x ARS25 Socket & 2 x ARS25 Plugs



LS31 FOAM LANCE WITH TANK

Part No.	Description
LS31	Foamer with 1L Tank

- 2,300 PSI Max Pressure
- 5.3 GPM Max Flow
- 140°F Max Temperature
- 1/4" BSP-F Inlet
- 1.25 mm Nozzle
- Replacement 2L Tank 14650200P



RL34/RL82 - FOAM GUN

Part No.	Inlet
RL34	1/2" BSP-F SW
RL82	1/2" BSP-F SW SS

- 2,900 PSI Rated Pressure
- 21 GPM Max Flow
- 320°F Max Temperature
- 1/2" BSP-F Outlet
- RL34 - Brass
- RL82 - Stainless Steel



RPS SS FOAM BALL VALVES

Part No.	Description
29100000P	303 SS Handle (A)
29103000P	303 SS Butterfly (D)
29105000P	316 SS Handle (B)
29108000P	316 SS Butterfly (C)

- 350 PSI Max Pressure
- 21 GPM Max Flow
- 195°F Max Temperature
- 1/2" BSP-F Inlet/Outlet
- Stainless Steel Ball Valves

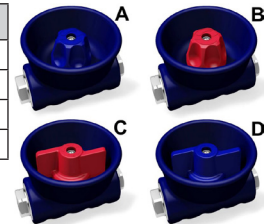

SGF/SGM INLET FITTINGS

Part No.	Inlet
SGF0004BR	1/2" NPT-F
SGM0004BRXLBP	1/2" NPT-M

- 150 PSI Max Pressure
- 8 GPM Max Flow
- 140°F Max Temperature
- Garden Hose Adapter



GP680073 INLET FITTING

Part No.	Inlet
GP680073	1/2" BSP-M

- 150 PSI Max Pressure
- 8 GPM Max Flow
- 140°F Max Temperature
- Garden Hose Adapter

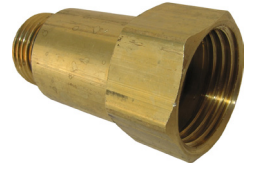

D10010 INLET FITTING

Part No.	Inlet	Outlet
D10010	3/4" M	1/2" QD-M

- 150 PSI Max Pressure
- 8 GPM Max Flow
- 140°F Max Temperature
- Garden Hose Assembly



D10011 INLET FITTING

Part No.	Inlet	Outlet
D10011	3/4" M	1/2" QD-M

- 150 PSI Max Pressure
- 8 GPM Max Flow
- 140°F Max Temperature
- Plug



D10012 INLET FITTING

Part No.	Inlet	Outlet
D10012	3/4" M	1/2" QD-M

- 150 PSI Max Pressure
- 8 GPM Max Flow
- 140°F Max Temperature
- Coupler



38000035 GARDEN HOSE STRAINER

Part No.	Description
38000035	Garden Hose Strainer

- 150 PSI Max Pressure
- 5 GPM Max Flow
- 140°F Max Temperature
- 50 Mesh Stainless Steel Screen



WFI INLET FILTERS

Part No.	Inlet	Outlet
WFI	1/2" NPT-F	1/2" NPT-M

- 145 PSI Max Pressure
- 5.8 GPM Max Flow
- 140°F Max Temperature
- 50 Mesh Screen



GP100651/52 ADAPTER WITH STRAINER

Part No.	Inlet	Outlet
GP100651	3/4" GH	1/2" NPT-M
GP100652	3/4" GH	3/8" NPT-M

- 150 PSI Max Pressure
- 8.0 GPM Max Flow
- 1/4" NPT-F Bypass Port
- 60 Mesh Screen



F11/F21 CHEMICAL FILTERS

Part No.	Description
F11	Standard Filter-Red
F21	With Check Valve-Green

- 1/4" Hose Barb
- Plastic & Brass Construction
- 4.0 oz Weight



KING NIPPLES

Part No.	Description
KN12	1/2" NPT-M to 1 1/4" Hose Barb
KN34	3/4" NPT-M to 1 1/2" Hose Barb

- Plated Steel
- Special conical internal profile to help provide a laminar flow into the inlet of the pump
- Ideal for gravity feed systems

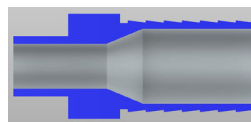
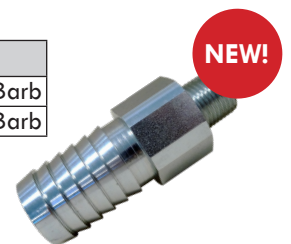

STRAINERS

PA POLY Y STRAINERS

Part No.	Description
28015000P	3/4" BSP-F
28015500P	1" BSP-F
28015253P	50 Mesh Screen

- 145 PSI Max Pressure
- 21 GPM Max Flow
- 140°F Max Temperature
- 50 Mesh Stainless Steel Screen



PA BRASS Y STRAINERS

Part No.	Ports NPT	SS Mesh
28016250P	1/2" NPT-F	45 SS
28016400P	3/4" BSP-F	45 SS

- 175 PSI Max Pressure
- 28016250P - 8 GPM Max Flow
- 28016400P - 10 GPM Max Flow
- 195°F Max Temperature
- 45 Mesh Stainless Steel Screen

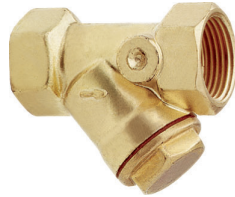

DEMA BRASS Y STRAINER

Part No.	Ports NPT	SS Mesh
DCS2B40	1/4" NPT-F	40 SS
DCS2B80	1/4" NPT-F	80 SS
DCS3B40	3/8" NPT-F	40 SS
DCS3B80	3/8" NPT-F	80 SS
DCS4B40	1/2" NPT-F	40 SS
DCS4B80	1/2" NPT-F	80 SS
DCS6B40	3/4" NPT-F	40 SS
DCS6B80	3/4" NPT-F	80 SS

- 300 PSI Max Pressure
- 140°F Max Temperature
- Corrosive Resistance Stainless Steel Screen

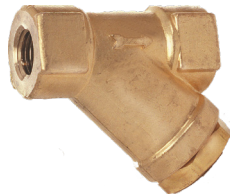

IFC BRONZE Y STRAINER

Part No.	Ports NPT	SS Mesh	Drain Port Size
YT125B0075011	3/4" NPT-F	50 SS	3/8"
YT125B0100011	1" NPT-F	50 SS	1/2"
YT125B0150011	1 1/2" NPT-F	50 SS	1/2"
YT125B0200011	2" NPT-F	50 SS	1/2"

- 200 PSI Max Pressure
- 400°F Max Temperature



HYPRO NYLON IN-LINE STRAINERS

Part No.	Ports NPT	SS Mesh
3350-0085F	1/4" F Inlet	20 SS
3350-0079F		50 SS
3350-0082F	1/2" M Outlet	80 SS
3350-0131	1/2" NPT-F	20 SS
3350-0042		50 SS
3350-0068		80 on 20 SS
3350-0132	3/4" NPT-F	20 SS
3350-0044		50 SS
3350-0045		80 on 20 SS
3350-0060	1" NPT-F	20 SS
3350-0061		50 SS
3350-0062	1-1/4" NPT-F	80 on 20 SS
3350-0074		20 SS
3350-0075	1-1/2" NPT-F	50 SS
3350-0076		80 on 20 SS
3350-0115	1-1/2" NPT-F	20 SS
3350-0116		50 SS
3350-0117		80 on 20 SS

- Nylon Body with Viton Gaskets
- 150 PSI Max Pressure at 70°F
- 304 Stainless Steel Screens
- Replacement Buna-N Gaskets Available
- Add "P" to end of Part Number for Clear Bowl



HYPRO POLYPROPYLENE IN-LINE STRAINERS

Part No.	Ports NPT	SS Mesh
3350-0085A	1/4" F Inlet	20 SS
3350-0079A		50 SS
3350-0082A	1/2" M Outlet	80 SS
3350-0085A	1/2" NPT-F	20 SS
3350-0046A		50 SS
3350-0043A		80 on 20 SS
3350-0040A	3/4" NPT-F	20 SS
3350-0034A		50 SS
3350-0035A		80 on 20 SS
3350-0057A	1" NPT-F	20 SS
3350-0058A		50 SS
3350-0059A		80 on 20 SS
3350-0071A	1-1/4" NPT-F	20 SS
3350-0072A		50 SS
3350-0073A		80 on 20 SS
3350-0112A	1-1/2" NPT-F	20 SS
3350-0113A		50 SS
3350-0114A		80 on 20 SS

- Polypropylene Body with EPDM Gaskets
- 80 PSI Max Pressure at 70°F
- 304 Stainless Steel Screens



BOLTED BALL VALVES

GREENLEAF Bolted Ball Valves are made with Stainless Steel bolts and precision molded polypropylene. The polypropylene is reinforced with fiberglass for additional strength. Self-aligning ball moves freely against the Teflon seats for smooth operation. The valve opens and closes with very little pressure on the handle. Ball is diamond turned, after molding to make it spherically perfect which provides precise contact between the ball and the seats. They come with Viton O-rings and Teflon self-lubricated stem bushings.

4 BOLT BALL VALVES

Part No.	Description
AGV050FP	1/2" - Full Port
AGV075FP	3/4" - Full Port
AGV125FP	1-1/4" - Full Port
AGV200	2" - Standard Port

- 75 PSI @ 150°F
- 150 PSI @ 70°F



6 BOLT BALL VALVES

Part No.	Description
AGV200FP	2" - Full Port
AGV300	3" - Standard Port
AGV300FP	3" - Full Port

- 75 PSI @ 150°F
- 150 PSI @ 70°F



TRUE UNION BALL VALVES

True Union Ball Valves are in-line repairable ball valves offer sturdy construction of chemically resistant polypropylene. Precision machined ball and multiple O-rings prevent leaking. 125 PSI @ 140°F. Teflon seats and EPDM seals are standard.

LONG LEVER HANDLE TYPE

Part No.	Port Size
AGTU50E	1/2"
AGTU75E	3/4"
AGTU100E	1"
AGTU125E	1-1/4"
AGTU150E	1-1/2"
AGTU200E	2"



OPTIONAL LEVER HANDLES

Part No.	Fits Port Sizes
AGTU25	1/2" thru 1"
AGTU26	1-1/4" thru 2"



GEOLINE BALL VALVES

GEOLINE Ball Valves precision molded in glass reinforced polypropylene for strength and chemical resistance. They come with Teflon Seats for smooth operation and double O-Rings are used for resistance to most chemicals.

Part No.	Port Size
AGSU12	1/2"
AGSU34	3/4"
AGSU100	1"
AGSU114	1-1/4"
AGSU112	1-1/2"
AGSU200	2"

- 240 PSI Max Operating Pressure



LOW PRESSURE BALL VALVES & FITTINGS

GREENLEAF - CAM COUPLERS

LOCKING CAM COUPLERS

GREENLEAF Locking Cam Couplers features an exclusive cam lever locking mechanism which helps reduce the possibility of the unintentional opening of the cam lever which could result in injury or costly spills. Parting lines have been removed from the sealing area of the male couplings reducing the possibility of leaks and wear to the rubber seals. The extended nipple length of the Locking Series B allows this coupling to be used in applications which would normally require an additional fitting in order to properly cam.

- 1/2" Couplings interchange with 3/4" Couplings
- 1/4" Couplings interchange with 1" Couplings
- Coupling ends are 1"



LOCKING SERIES - B FEMALE LEVER COUPLER - MPT

Part No.	Size
AGGLP050B	1/2"
AGGLP075B	3/4"
AGGLP100B	1"
AGGLP125B	1-1/4"
AGGLP150B	1-1/2"
AGGLP200B	2"



LOCKING SERIES - C FEMALE LEVER COUPLER - HOSE SHANK

Part No.	Size
AGGLP050C	1/2"
AGGLP075C	3/4"
AGGLP100C	1"
AGGLP125C	1-1/4"
AGGLP150C	1-1/2"
AGGLP200C	2"



LOCKING SERIES - D FEMALE LEVER COUPLER - FPT

Part No.	Size
AGGLP050D	1/2"
AGGLP075D	3/4"
AGGLP100D	1"
AGGLP125D	1-1/4"
AGGLP150D	1-1/2"
AGGLP200D	2"



LOCKING SERIES CAP FEMALE LEVER COUPLER - FTP

Part No.	Dust Cap Size
AGGLP050CAP	1/2"
AGGLP075CAP	3/4"
AGGLP100CAP	1"
AGGLP125CAP	1-1/4"
AGGLP150CAP	1-1/2"
AGGLP200CAP	2"



EPDM REPLACEMENT GASKETS

Part No.	Fits Coupler Sizes
AG90043	1/2" & 3/4"
AG90042	1" & 1-1/4"
AG90041	1-1/2"
AG90040	2"



2" - 90° CAM COUPLERS & ADAPTERS

Part No.	Description
AG200A-90	2" Adapter with FPT
AG200C-90	2" Coupler with Hose Shank
AG200D-90	2" Coupler with FPT
AG200F-90	2" Adapter with MPT



- 125 PSI
- Manufactured from Glass Reinforced Polypropylene
- Interchangeable with other Couplers & Adapters
- Chemically Resistant
- Stainless Steel Hardware
- EPDM Gaskets

NON-LOCKING SERIES - A MALE ADAPTER - FPT

Part No.	Size
AGGLP050A	1/2"
AGGLP075A	3/4"
AGGLP100A	1"
AGGLP125A	1-1/4"
AGGLP150A	1-1/2"
AGGLP200A	2"
AGGLP300A	3"



NON-LOCKING SERIES - B FEMALE LEVER COUPLER - MPT

Part No.	Size
AGGLP050BNL	1/2"
AGGLP075BNL	3/4"
AGGLP100BNL	1"
AGGLP125BNL	1-1/4"
AGGLP150BNL	1-1/2"
AGGLP200BNL	2"
AGGLP300BNL	3"



NON-LOCKING SERIES - C FEMALE LEVER COUPLER - HOSE SHANK

Part No.	Size
AGGLP050CNL	1/2"
AGGLP075CNL	3/4"
AGGLP100CNL	1"
AGGLP125CNL	1-1/4"
AGGLP150CNL	1-1/2"
AGGLP200CNL	2"
AGGLP300CNL	3"



NON-LOCKING SERIES - D FEMALE LEVER COUPLER - FPT

Part No.	Size
AGGLP050DNL	1/2"
AGGLP075DNL	3/4"
AGGLP100DNL	1"
AGGLP125DNL	1-1/4"
AGGLP150DNL	1-1/2"
AGGLP200DNL	2"
AGGLP300DNL	3"



NON-LOCKING SERIES - E MALE ADAPTER - HOSE SHANK

Part No.	Size
AGGLP050E	1/2"
AGGLP075E	3/4"
AGGLP100E	1"
AGGLP125E	1-1/4"
AGGLP150E	1-1/2"
AGGLP200E	2"
AGGLP300E	3"



NON-LOCKING SERIES - F MALE ADAPTER - MPT

Part No.	Size
AGGLP050F	1/2"
AGGLP075F	3/4"
AGGLP100F	1"
AGGLP125F	1-1/4"
AGGLP150F	1-1/2"
AGGLP200F	2"
AGGLP300F	3"



NON-LOCKING SERIES - PL PLUG FOR FEMALE ADAPTER

Part No.	Size
AGGLP050PL	1/2"
AGGLP075PL	3/4"
AGGLP100PL	1"
AGGLP125PL	1-1/4"
AGGLP150PL	1-1/2"
AGGLP200PL	2"
AGGLP300PL	3"



NON-LOCKING SERIES - CAP CAP FOR MALE ADAPTER

Part No.	Size
AGGLP050CAPNL	1/2"
AGGLP075CAPNL	3/4"
AGGLP100CAPNL	1"
AGGLP125CAPNL	1-1/4"
AGGLP150CAPNL	1-1/2"
AGGLP200CAPNL	2"
AGGLP300CAPNL	3"



POLYPROPYLENE FITTINGS

AGTF - BLACK DOUBLE THREADED BULKHEAD FITTINGS

Part No.	FTP Size	Sealing Washer
AGTF12PE	1/2"	EDPM
AGTF34PB	3/4"	BUNA
AGTF34PE	3/4"	EDPM
AGTF100PE	1"	EDPM
AGTF125PE	1-1/4"	EDPM
AGTF150PE	1-1/2"	EDPM
AGTF200PE	2"	EDPM



- For use with Tanks with a Wall Thickness of 1-1/16" To 1/2"
- Standard with EPDM Sealing Basket and Polyethylene Friction Gasket

- External Thread and Nut are Left-Hand Threads
- Internal Thread is FTP
- FDA Approved

OF - OUTLET FLANGES

Part No.	Size	Port Type
AGOF125	1-1/4"	Full Port
AGOF150	1-1/2"	Full Port
AGOF200FP	2"	Full Port



- For use when access to Inside of Tanks with a Wall Thickness of 1/4" to 1/2" is Available
- EPDM Gasket
- Stainless Steel Bolts, Nuts and Washers

AGB3400 - SWIVEL NUTS

Part No.	Connection
AGB3400FP	3/4" SPT
AGB3400P	3/4" FGHT



AG8027- SWIVEL NUT NOZZLE FITTINGS

Part No.	Connection
AG8027P	11/16" Female UN
AG8027WP	11/16" Female UN with wings



GARDEN HOSE ADAPTERS

Part No.	Connection: 3/4" MGHT x
AGD3414P	1/4" BARB
AGD3438P	3/8" BARB
AGE3438P	3/8" MPT
AGD3412P	1/2" BARB
AGE3412P	1/2" MPT
AGG3412P	1/2" FPT
AGD3458P	5/8" BARB
AGD3434P	3/4" BARB
AGE3434P	3/4" MPT
AGEE3434P	3/4" MGHT
AGG3434P	3/4" FPT
AGD3410P	1" BARB



AG1116 - NOZZLE FITTINGS FEMALE ADAPTERS

Part No.	Connection
AG1116AP	11/16" Female UN x 1/4" FPT
AG1116BP	11/16" Female Slip-Through



AGNB- NOZZLE FITTING ADAPTER

Part No.	Connection
AGNB164P	11/16" Male UN x 1/4" MPT



AG38- NOZZLE FITTINGS STRAIGHT ADAPTERS - NUT INCLUDED

Part No.	Connection
AG3838DP	11/16" Male UN x 3/8" BARB
AG3812DP	11/16" Male UN x 1/2" BARB
AG3834DP	11/16" Male UN x 3/4" BARB



STRAIGHT ADAPTERS - MPT

Part No.	Connection
AGA1814P	1/8" MPT x 1/4" BARB
AGA1838P	1/8" MPT x 3/8" BARB
AGA1812P	1/8" MPT x 1/2" BARB
AGA1414P	1/4" MPT x 1/4" BARB
AGA1438P	1/4" MPT x 3/8" BARB
AGA1412P	1/4" MPT x 1/2" BARB
AGA1458P	1/4" MPT x 5/8" BARB
AGA1434P	1/4" MPT x 3/4" BARB
AGA3814P	3/8" MPT x 1/4" BARB
AGA3838P	3/8" MPT x 3/8" BARB
AGA3858P	3/8" MPT x 5/8" BARB
AGA3834P	3/8" MPT x 3/4" BARB
AGA1214P	1/2" MPT x 1/4" BARB
AGA1238P	1/2" MPT x 3/8" BARB
AGA1212P	1/2" MPT x 1/2" BARB
AGA1258P	1/2" MPT x 5/8" BARB
AGA1234P	1/2" MPT x 3/4" BARB
AGA12114P	1/2" MPT x 1-1/4" BARB
AGA1210P	1/2" MPT x 1" BARB
AGA3414P	3/4" MPT x 1/4" BARB
AGA3412P	3/4" MPT x 1/2" BARB
AGA3458P	3/4" MPT x 5/8" BARB
AGA3434P	3/4" MPT x 3/4" BARB
AGA3410P	3/4" MPT x 1" BARB
AGA34114P	3/4" MPT x 1-1/4" BARB
AGA1038P	1" MPT x 3/8" BARB
AGA1012P	1" MPT x 1/2" BARB
AGA1058P	1" MPT x 5/8" BARB
AGA1034P	1" MPT x 3/4" BARB
AGA1114P	1" MPT x 1-1/4" BARB
AGA1010P	1" MPT x 1" BARB
AGA11434P	1-1/4" MPT x 3/4" BARB
AGA1141P	1-1/4" MPT x 1" BARB
AGA114P	1-1/4" MPT x 1-1/4" BARB
AGA114112P	1-1/4" MPT x 1-1/2" BARB
AGA112114P	1-1/2" MPT x 1-1/4" BARB
AGA112P	1-1/2" MPT x 1-1/2" BARB
AGA112200P	1-1/2" MPT x 2" BARB
AGA200112P	2" MPT x 1-1/2" BARB
AGA200P	2" MPT x 2" BARB



COUPLINGS - FEMALE

Part No.	Connection
AGFTC12P	1/2" FPT x 1/2" FPT
AGJ3412P	3/4" FGHT x 1/2" FPT
AGFTC34P	3/4" FPT x 3/4" FPT
AGFTC100P	1" FPT x 1" FPT
AGFTC114P	1-1/4" FPT x 1-1/4" FPT
AGFTC112P	1-1/2" FPT x 1-1/2" FPT
AGFTC200P	2" FPT x 2" FPT



HEX NIPPLES

Part No.	Connection
AGM1400P	1/4" MPT x 1/4" MPT
AGM3800P	3/8" MPT x 3/8" MPT
AGM1200P	1/2" MPT x 1/2" MPT
AGM3400P	3/4" MPT x 3/4" MPT
AGM1000P	1" MPT x 1" MPT
AGM1140P	1-1/4" MPT x 1-1/4" MPT
AGM1120P	1-1/2" MPT x 1-1/2" MPT
AGM2000P	2" MPT x 2" MPT



REDUCER NIPPLES

Part No.	Connection
AGRM1438P	1/4" MPT x 3/8" MPT
AGRM3812P	3/8" MPT x 1/2" MPT
AGRM38116P	3/8" MPT x 11/16" MPT
AGRM1214P	1/2" MPT x 1/4" MPT
AGRM12116P	1/2" MPT x 11/16" MPT
AGRM3438P	3/4" MPT x 3/8" MPT
AGRM3412P	3/4" MPT x 1/2" MPT
AGRM34116GP	3/4" MPT x 11/16" MPT
AGRM34116P	3/4" MPT x 11/16" MPT
AGRM1141P	1-1/4" MPT x 1" MPT



REDUCER BUSHINGS

Part No.	Connection
AGRB1418P	1/4" MPT x 1/8" FPT
AGRB3818P	3/8" MPT x 1/8" FPT
AGRB3814P	3/8" MPT x 1/4" FPT
AGRB1218P	1/2" MPT x 1/8" FPT
AGRB1214P	1/2" MPT x 1/4" FPT
AGRB1238P	1/2" MPT x 3/8" FPT
AGRB3418P	3/4" MPT x 1/8" FPT
AGRB3414P	3/4" MPT x 1/4" FPT
AGRB3438P	3/4" MPT x 3/8" FPT
AGRB3412P	3/4" MPT x 1/2" FPT
AGRB1012P	1" MPT x 1/2" FPT
AGRB1034P	1" MPT x 3/4" FPT
AGRB11434P	1-1/4" MPT x 3/4" FPT
AGRB1141P	1-1/4" MPT x 1" FPT
AGRB11234P	1-1/2" MPT x 3/4" FPT
AGRB1121P	1-1/2" MPT x 1" FPT
AGRB112114P	1-1/2" MPT x 1-1/4" FPT
AGRB2001P	2" MPT x 1" FPT
AGRB200114P	2" MPT x 1-1/4" FPT
AGRB200112P	2" MPT x 1-1/2" FPT
AGRB300200P	3" MPT x 2" FPT



STRAIGHT ADAPTERS - FPT

Part No.	Connection
AGAF1212P	1/2" FPT x 1/2" BARB
AGAF3458P	3/4" FPT x 5/8" BARB
AGAF3434P	3/4" FPT x 3/4" BARB



CAP - CLOSED END

Part No.	Connection
AGN3400P	3/4" FGHT
AGN3400FP	3/2" FPS



POLYPROPYLENE FITTINGS

PIPE PLUGS

Part No.	Connection
AGF1800P	1/8" MPT
AGF1400P	1/4" MPT
AGF3800P	3/8" MPT
AGF1200P	1/2" MPT
AGF3400P	3/4" MPT
AGF1000P	1" MPT
AGF1014P	1-1/4" MPT



GARDEN HOSE PLUGS

Part No.	Connection
AGF3400HTP	3/4" MGHT



NOZZLE FITTINGS - SPRAY TIP BLANK

Part No.	Description
AG8028P	Cap with 11/16" Female UN



NOZZLE FITTINGS - ELBOW NUT INCLUDED

Part No.	Connection
AGNTL38P	11/16" Male UN x 3/8" BARB
AGNTL12P	11/16" Male UN x 1/2" BARB
AGNTL34P	11/16" Male UN x 3/4" BARB



90 DEGREE ELBOW - BARB

Part No.	Connection
AGEB1414P	1/4" BARB x 1/4" BARB
AGEB3838P	3/8" BARB x 3/8" BARB
AGEB1212P	1/2" BARB x 1/2" BARB
AGEB5858P	5/8" BARB x 5/8" BARB
AGEB3434P	3/4" BARB x 3/4" BARB
AGEB114P	1-1/4" BARB x 1-1/2" BARB
AGEB112P	1-1/2" BARB x 1-1/2" BARB
AGEB200P	2" BARB x 2" BARB



90 DEGREE STREET ELBOW

Part No.	Connection
AGSE14P	1/4" MPT x 1/4" FPT
AGSE38P	3/8" MPT x 3/8" FPT
AGSE12P	1/2" MPT x 1/2" FPT
AGSE34P	3/4" MPT x 3/4" FPT
AGSE100P	1" MPT x 1" FPT
AGSE114P	1-1/4" MPT x 1-1/4" FPT
AGSE112P	1-1/2" MPT x 1-1/2" FPT
AGSE200P	2" MPT x 2" FPT



90 DEGREE ELBOW - FPT

Part No.	Connection
AGELF100P	1" FPT x 1" FPT
AGELF112P	1-1/2" FPT x 1-1/2" FPT
AGELF114P	1-1/4" FPT x 1-1/4" FPT
AGELF12P	1/2" FPT x 1/2" FPT
AGELF200P	2" FPT x 2" FPT
AGELF34P	3/4" FPT x 3/4" FPT
AGEL1212FP	1/2" FPT x 1/2" BARB
AGEL3412FP	3/4" FPT x 1/2" BARB
AGEL3434FP	3/4" MPT x 3/4" BARB



90 DEGREE ELBOW - MPT

Part No.	Connection
AGEL1814P	1/8" MPT x 1/4" BARB
AGEL1414P	1/4" MPT x 1/4" BARB
AGEL1438P	1/4" MPT x 3/8" BARB
AGEL1412P	1/4" MPT x 1/2" BARB
AGEL1458P	1/4" MPT x 5/8" BARB
AGEL3814P	3/8" MPT x 1/4" BARB
AGEL3838P	3/8" MPT x 3/8" BARB
AGEL3812P	3/8" MPT x 1/2" BARB
AGEL3858P	3/8" MPT x 5/8" BARB
AGEL1214P	1/2" MPT x 1/4" BARB
AGEL1238P	1/2" MPT x 3/8" BARB
AGEL1212P	1/2" MPT x 1/2" BARB
AGEL1258P	1/2" MPT x 5/8" BARB
AGEL1234P	1/2" MPT x 3/4" BARB
AGEL3414P	3/4" MPT x 1/4" BARB
AGEL3438P	3/4" MPT x 3/8" BARB
AGEL3412P	3/4" MPT x 1/2" BARB
AGEL3458P	3/4" MPT x 5/8" BARB
AGEL3434P	3/4" MPT x 3/4" BARB
AGEL3410P	3/4" MPT x 1" BARB
AGEL1038P	1" MPT x 3/8" BARB
AGEL1012P	1" MPT x 1/2" BARB
AGEL1058P	1" MPT x 5/8" BARB
AGEL1034P	1" MPT x 3/4" BARB
AGEL1010P	1" MPT x 1" BARB
AGEL1114P	1" MPT x 1-1/4" BARB
AGEL11434P	1-1/4" MPT x 3/4" BARB
AGEL1141P	1-1/4" MPT x 1" BARB
AGML1141P	1-1/4" MPT x 1" MPT
AGEL114P	1-1/4" MPT x 1-1/4" BARB
AGEL112P	1-1/2" MPT x 1-1/2" BARB
AGEL200P	2" MPT x 2" BARB



FLAT SEAT HOSE - BARB

Part No.	Connection
AGC1800P	1/8" MPT
AGC1400P	1/4" MPT
AGC3800P	3/8" MPT
AGC1200P	1/2" MPT
AGC5800P	5/8" MPT
AGC3400P	3/4" MPT



THREADED TEE

Part No.	Connection
AGTT18P	1/8" x 1/8" x 1/8" FPT
AGTT14P	1/4" x 1/4" x 1/4" FPT
AGTT3414P	1/4" x 1/4" x 3/4" FPT
AGTT12P	1/2" x 1/2" x 1/2" FPT
AGTT3418P	3/4" x 3/4" x 1/8" FPT
AGTT34P	3/4" x 3/4" x 3/4" FPT
AGTT100P	1" x 1" x 1" FPT
AGTT114P	1-1/4" x 1-1/4" x 1-1/4" FPT
AGTT112P	1-1/2" x 1-1/2" x 1-1/2" FPT
AGTT200P	2" x 2" x 2" FPT



3-PIECE BARB ASSEMBLY

Part No.	Connection
AGB3458WP	3/4" FGHT x 5/8" BARB



STRAIGHT HOSE MENDER

Part No.	Connection
AGSHM1800P	1/8" BARB x 1/8" BARB
AGSHM3160P	3/16" BARB x 3/16" BARB
AGSHM1400P	1/4" BARB x 1/4" BARB
AGSHM5160P	5/16" BARB x 5/16" BARB
AGSHM3814P	3/8" BARB x 1/4" BARB
AGSHM3800P	3/8" BARB x 3/8" BARB
AGSHM1238P	1/2" BARB x 3/8" BARB
AGSHM1200P	1/2" BARB x 1/2" BARB
AGSHM1258P	1/2" BARB x 5/8" BARB
AGSHM5800P	5/8" BARB x 5/8" BARB
AGSHM3400P	3/4" BARB x 3/4" BARB
AGSHM1000P	1" BARB x 1" BARB
AGSHM114P	1-1/4" BARB x 1-1/4" BARB
AGSHM112P	1-1/2" BARB x 1-1/2" BARB
AGSHM2000P	2" BARB x 2" BARB



NOZZLE FITTING - METERING BARB

Part No.	Connection
AGK8414P	1/4" BARB
AGK8438P	3/8" BARB
AGK8412P	1/2" BARB



NOZZLE FITTINGS - TEE NUT INCLUDED

Part No.	11/16" Male UN x
AGNTT38P	3/8" BARB
AGNTT12P	1/2" BARB
AGNTT34P	3/4" BARB



CROSS BARB

Part No.	Connection
AGX14P	1/4" BARB



INSERT TEE

Part No.	Connection
AGT18P	1/8" x 1/8" x 1/8" BARB
AGT14P	1/4" x 1/4" x 1/4" BARB
AGT38P	3/8" x 3/8" x 3/8" BARB
AGT3812P	1/2" x 1/2" x 3/8" BARB
AGT12P	1/2" x 1/2" x 1/2" BARB
AGT3412P	1/2" x 1/2" x 3/4" BARB
AGT58P	5/8" x 5/8" x 5/8" BARB
AGT34P	3/4" x 3/4" x 3/4" BARB
AGT100P	1" x 1" x 1" BARB
AGT114P	1-1/4" x 1-1/4" x 1-1/4" BARB
AGT112P	1-1/2" x 1-1/2" x 1-1/2" BARB
AGT200P	2" x 2" x 2" BARB



NOZZLE FITTINGS - CROSS

Part No.	11/16" Male UN x
AGT38CP	3/8" BARB
AGT12CP	1/2" BARB
AGT34CP	3/4" BARB



HOT WATER COMPONENTS

BURNER ASSEMBLIES

Part No.	Description	For Dynablast Model
JB101	ADC Burner - F22 Head - No Nozzle - 13.5VDC	DGF/DDF/DEF/BEF Series
JB102	ADC Burner - F22 Head - 1.75 80A Nozzle 13.5VDC	DGF/DDF/DEF/BEF/DGFS Series
JB103	ADC Burner - F22 Head - 2.25 80A Nozzle - 13.5VDC	HV420FLS, CAB420FLS (Less Nozzle)
JB201	AFG Burner - F3 Head -1.00 90A Nozzle - 120VAC	DEF Series
JB303	SM Burner - F22 Head - 2.25 80A Nozzle - 230VAC	BEF Series
JB401	SM Burner - F22 Head - No Nozzle - 120VAC	BEF Series
JB501	SDC Burner - F310 Head - 4.00 80A Nozzle - 13.5VDC	HV690F And FLS
JB1001	CF800 Burner - 5.00 80B Nozzle -120VAC	HV900F And FLS
HWEP609	ADC Burner - F22 Head - Primary Control -13.5VDC	HV200FLS & HV300FLS (w. Mod), HV420FLS & CAB420FLS



BURNER MOTORS

Part No.	Description	For Dynablast Model
HW52145U	ADC 1/7HP 13.5VDC (Fan/Motor/Coupling)	13.5VDC, Heater Models 420,000 BTU or lower
HW52146U	SDC 1/4HP 13.5VDC (Fan/Motor/Coupling)	13.5VDC, Heater Models 590,000 BTU and Higher
HW21805U	AFG PSC 1/7HP 120VAC (Motor Only)	DEF Series
HW21173	SM 1/4HP 240VAC/60HZ (Motor Only)	BEF Series
HW2364U	SF 1/4HP 3450RPM-120VAC (Motor Only)	BEF Series (120VAC)
HW21341U	CF 1/3HP 120VAC/60HZ/1PH (Motor Only)	HV900F & FLS
HW2900U	SF 1/5HP 120VAC/60HZ/1PH	H4030BEF3A-B-C-D, MHG400F
HW22825U	220/240VAC 1/7HP	AF AFG NX Burners
HW2495U	220VAC 2850RPM 1/4HP	BEF Series
HWHE21126	Wayne EH Burner Motor	HV700F & FLS



THERMOSTATS & TEMPERATURE DEVICES

Part No.	Description	For Dynablast Model
GP100438	HW Thermostat 230°F	Hot Water Pressure Washers
GP100439	Steam Thermostat 325°F	Steam Pressure Washers
GP100538	HW Thermostat 86°F - 250°F	Replacement For HWTR86
HWTR92	HW Thermostat 194°F	STD on HW Pressure Washers & Hydrovac Heaters
HWTR90	High Pressure Thermostat	Used On SCH160 Coils Rated For 5,000PSI
HWMC7211LED	120VAC Temperature Controller	HV700, HV900 F & FLS
HWELATS7799-11N	Thermocouple	HV700, HV900 F & FLS
HWELATS7799-RTD	RTD Temperature Device	Hydrovac Heater
HWT44110NL	110°C High Limit	STD on HW Pressure Washers & Hydrovac Heaters
HWT44165	325°F High Limit	Used only on Steam Models
HWELNATTD18125RWL	125°F High Limit	Hydrovac Heater
HWELNATTD18170RWL	170°F High Limit	Hydrovac Heater
HWELNATTD18200RWL	200°F High Limit	Hydrovac Heater
HWEL8036297	Temp. Sensor (Duel Temp Settings)	Hydrovac Heater



PRIMARY CONTROLS

Part No.	Description	For Dynablast Model
HWHE7556P052MU	12VDC Primary control Programmed: Pre-time 5 sec, Post-time 2 min	HV200, HV300, HV400, HV590, HV690, CAB420 & HDC Series
HW7556	12VAC Primary Control	HV200, HV300, HV420, HV590, HV690
HW7505A0000U	120VAC Primary Control	HV700, HV900 F & FLS (Needs 220OHM, 2 Watt Resistor)
HWHE7575	120VAC Primary Control - Potted	HV700, HV900 F & FLS (Needs 220OHM, 2 Watt Resistor)
HWHE7580	240VAC Primary Control - Potted	HV700, HV900 F & FLS (Needs 220OHM, 2 Watt Resistor)



FUEL PUMPS

Part No.	Description	For Dynablast Model
HWPF20372	Pump 1/S 3 GPH A2EA-6527 (12VDC/24VAC Coil)	ADC Burner
HWPF20321U	Universal Clean Cut Pump (120 VAC coil)	AF & AFG Burner
HWPF20322U	Clean Cut A2EA-6527 (120VAC Coil)	SM Burner
HWPF226N2U	1/S 7GPH A2YA-7916/PF126N2	CF800, SDC Burner - HV590, HV690, HV900
HWPF203N2U	7GPH, A2VA-7116/PF103N2U	SF Burner
HWHE21369U	Wayne EH Burner Fuel Pump	HV700 F & FLS



PUMP PARTS & ACCESSORIES

Part No.	Description	For Dynablast Model
HW21877U	Valve Stem - Fits PF103	Beckett Oil Burner Fuel Pumps
HW21807U	Cordset 13" Non Delay	Beckett Fuel Pumps
HW3713823U	Solenoid Coil 12VDC /24VAC - Fits PF20372	All 12VDC/24VAC Beckett Burners
HW3713824U	Solenoid Coil 120VAC Fits PF20322	BEF Series, MHG400F 120VAC
HW3713798U	Solenoid Coil 220VAC	220VAC Beckett Burner
HW071N0807U	Solenoid Coil 12VDC Fits PF10363	ADC & SDC Beckett Oil Burners
HWSP150281U	Clean Cut Strainer Kit	A2VA7116, A2VA3006 & Cleancut Beckett Pumps
HWSPG33112BU	Clean Cut Pump Gasket (6 Pcs)	A2VA7116, A2VA3006 & Cleancut Beckett Pumps
HWHE140RF	Fuel Filter Element	HV, CAB Heaters, HDC Model
HWHE140R	Fuel Filter Housing & Element	HV, CAB Heaters, HDC Model
HW33001	Fuel Filter	H3025DGF, H4035DGF(S), HS4035DGF(S), HK4035DGF HK4030DDF, DEF & BEF Series
HW100610-001	Wayne Burner Fuel Solenoid	HV700FLS, HV700F



ELECTRODE INSULATOR ASSEMBLERS

Part No.	Description	For Dynablast Model
HW578728	Electrode Kit For AF44 ATC	JB101, JB102, JB103, JB201
HW5780	Electrodes F Head up to 9"	AF, AFG
HW5940	Electrodes M Head up to 9"	AFG
HWHE13286	Electrodes Wayne EH Burner	HV700 F & FLS

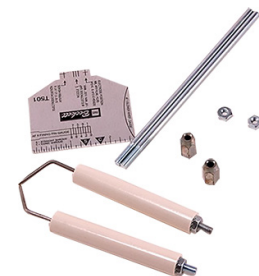

HOT WATER COMPONENTS

IGNITERS

Part No.	Description	For Dynablast Model
HW5270001U	ADC Burner 5218301U (Old #)	H3025DGF, H4035DGF, HV200, HV300, HV420, CAB420
HW5270002U	SDC Burner 5218303U (Old #)	HV590 & HV690 F & FLS
HW51824U	CF800 Burner 120VAC	HV900 F & FLS
HW51827U	Wayne E Igniter	HV700, HV900 F & FLS
HW51771U	120VAC Igniter with AF/AFG Base Plates	H2015DEF1
HW51838U	120VAC Igniter (No Baseplate)	DEF Series
HW5250001U	240VAC Igniter AF/AFG	AFG Burners
HW5250002U	240VAC Igniter SF/SM	SF/SM Burners
HW5250005U	240VAC Igniter Only (No Baseplate)	AFG, SF/SM Burners

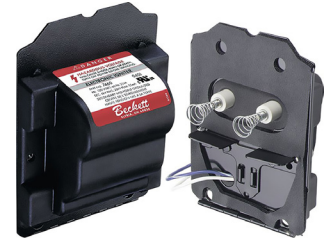

FLEX COUPLINGS & BURNER PARTS

Part No.	Description	For Dynablast Model
HW2290	Flex Coupling J Pump 7/16" Shaft	SF Burners
HW2433	Flex Coupling 5/16 A	Beckett Burners
HW2454	Flex Coupling A Pump 5/16" Shaft	Beckett Burners
HW2140501U	ADC Burner Coupling	HV200, HV300, HV420, H4030DDF, H4035DGF
HW2154101U	SDC Burner Coupling	HV590, HV690 F & FLS
HW5636	Fuel Oil Lines 6.5" (Short)	HV200, HV300, HV420, H4030DDF, H4035DGF
HW5394	Fuel Oil Lines 9.5"	HV590, HV690 F & FLS
HW51127	Fuel Oil Lines 11" (Long)	HV900F & FLS
HW3666U	Spline Nut	All Beckett Burners Except HV900
HW7006U	CAD Cell	All Fuel Oil Fired Hot Water Models
HWHE13279	Wayne EH Burner Coupling	HV700 F & FLS
HW14451	Fuel Tube EH Burner	
HW12484	Wayne EH Burner Gasket	



GAS VALVES

Part No.	Description	For Dynablast Model
HWHE36C03U-400	Millivolt Gas Valve	MHGSQ35N/P, MHG400N/P
HWHE36C03434	24VAC Gas Valve	MHG400N/P-24VAC, MHGE500NSQ/PSQ-24VAC
HWHE36C68423B	Electronic Ignition	NEI/PEI, UHE, BEN/P Series
HWHEV8944B1019	Natural Gas - Gas Valve	HV700N, HV900N
HWHEV8944C1017	Propane - Gas Valve	HV700P, HV900P



STANDING PILOT IGNITER

Part No.	Description	For Dynablast Model
HWHEQ3451ASSY	Electronic IGN Standing Pilot, Pilot Bracket & Pilot SS Shield	NEI/PEI, UHE, BEN/P SERIES
HWHEQ3451	Used With Electronic Ignition	NEI/PEI, UHE, BEN/P SERIES
HWHEQ379A1064	Used With Millivolt Generator & Thermocouple (24VAC)	MHGSQ35N/P, MHG400N/P



Part No.	Description	For Dynablast Model
HWHEG01A-502B1	36" MILLIVOLT GENERATOR	MHGSQ35N/P, MHG400N/P
HWHEH06E918	46CM THERMOCOUPLE	MHGSQ35NEI -24VAC/PEI -24VAC, MHGE400N-24VAC/P-24VAC, MHGE500NSQ-24VAC/PSQ-24VAC
HWEP24617	STAINLES STEEL PILOT SHIELD	All Dynablast Natural Gas & Propane Models
HWEP24831L-1	STANDING PILOT BRACKET	All Dynablast Natural Gas & Propane Models
HWHEV8046C	SOLENOID PILOT VALVE	MHG700N/P, MHG900N/P
HWHE8610H3018	60HZ Gas Ignition Module	NEI/PEI, UHE, BEN/P SERIES & MHG700N/P, MHG900N/P



BURNER TOOLS

Part No.
HWZ2000U

- Beckett Z Gauge for use on all Beckett Burners

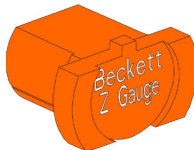

CONTRACTOR TOOL

Part No.
HW52082U

- Beckett Contractor Tool for use on Beckett Primary Controls



TECHTOP FARM DUTY 1-PHASE MOTORS

Part No.	HP Rating	Voltage	Amp Draw	Speed	Frame Size	Frame Type
FDR0014C-C-01	1.5	115/208/230	13.3/7.2/6.65	1750	56H	TEFC
FDR0014C-C-01-TC					56HC	
FDR0024C-01	2		17.3/10.4/8.65		56H	
FDR0024C-C-01-TC					56HC	
FDR0034B-01	3	208/230	14.3/12.9	182T		
FDR0034B-01-TC				182TC		
EM5.56C3400LC	5		19.2	3400	56HCZ	
FDR0054B01			23.2/21.0	1750	184T	
FDR0054B-01-TC	184TC					
FDR0074B-01	7.5	46.3/41.8	34.3/31.0	213TZ		
FDR0074B-01-TC				213TCZ		
FDR0104B-01	10		215T	215TC		
FDR0104B-01-TC						



TECHTOP 3-PHASE MOTORS

Part No.	HP Rating	Voltage	Amp Draw	Speed	Frame Size	Frame Type
GRC0024D-01	2	208/230/460	6.14/5.55/2.78	1750	145T	TEFC
GRC0024D-01-TC					145TC	
GRC0024F-01	575	2.22	145T			
GRC0024F-01-TC			145TC			
GRC0034D-01	3	208/230/460	8.79/7.95/3.97		182T	
GRC0034D-01-TC					182TC	
GRC0034F-01	575	3.18	182T			
GRC0034F-01-TC			182TC			
GRC0054D-01	5	208/230/460	13.94/12.6/6.3		184T	
GRC0054D-01-TC					184TC	
GRC0054F-01	575	5.04	184T			
GRC0054F-01-TC			184TC			
GRC0074D-01	7.5	208/230/460	20.16/18.23/9.12	213T		
GRC0074D-01-TC				213TC		
GRC0074F-01	575	7.29	213T			
GRC0074F-01-TC			213TC			
GRC0104D-01	10	208/230/460	26.54/24.0/12.0	215T		
GRC0104D-01-TC				215TC		
GRC0104F01	575	9.61	215T			
GRC0104F-01-TC			215TC			
GRC0154D-01	15	208/230/460	40.02/36.19/18.1	254T		
GRC0154F-01				575	14.48	
GRC0204D-01	20	208/230/460	50.6/45.76/22.88	256T		
GRC0204F-01				575	18.31	
GRC0254D-01	25	208/230/460	65.07/58.84/29.42	284T		
GRC0254F-01				575	23.54	
GRC0304D-01	30	208/230/460	76.29/68.99/34.49	286T		
GRC0304F-01				575	27.6	

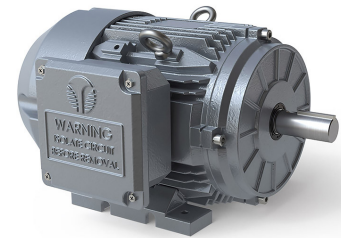

ALUMINUM PULLEYS

Part No.	Groove	Diameter	Bore
2PY100A24	2	100 mm	24 mm
2PY140A24	2	140 mm	24 mm
2PY160A24	2	160 mm	24 mm



FLEX COUPLERS

Part No.	Shaft Dimension
FC56C2405	24 mm x 5/8"
FC145TC2407	24 mm x 7/8"
FC184TC2409	24 mm x 1-1/8"
FC213215TC2411	24 mm x 1-3/8"

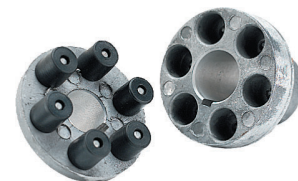

MOUNTING FLANGES

Part No.	HP	Motor Frame	Pump Series
MF56145C	2.0	56C, 145TC, 182TC	44, 51, 60, 63, Evo 2
MF184TC	5.0	184TC	44, 51, 60, 63, Evo 2
MF213215TC	15	184TC, 213TC, 215TC	47, 66, Evo 3

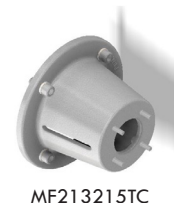
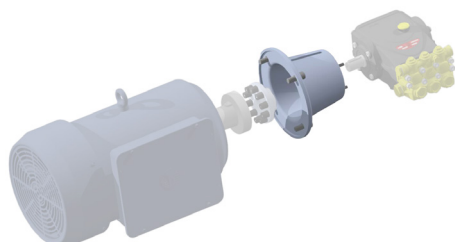

HYDRAULIC BELL HOUSING & FLEX COUPLERS

Part No.	Pump Series
ZFH/ZGH47SBKIT	Interpump Series 47 & 66
ZFH/ZGH70SBKIT	Pratissoli Series KE (70) Hydraulic Kit
ZFH/ZGH71SCKIT	Pratissoli Series KF, HF, VF (71) Hydraulic Kit

- Kit Includes Bell Housing, Flex Coupler and Mounting Hardware
- Easy to Install
- Mounts Directly on the Pump Saving Time on Installation
- Reduced Operating Costs
- Improved Pump Life Due to Proper Alignment with Hydraulic Motor



ZFHZGH47SBKIT



ZFHZGH70SBKIT

RS99 GEAR REDUCER

Part No.	Description	RPM	Pump Shaft	Max HP	For Pump Series
RS99	3/4" Input Shaft	1450	24 mm	5.0	Interpump 44, 60, 63, E2
Engine Speed 3400 RPM for Small Frame Engines SAE J609-A Flange 2.4:1 Gear Ratio					



B5 GEAR REDUCER

Part No.	Description	RPM	Pump Shaft	Max HP	For Pump Series
50060000P	3/4" Input Shaft	1450	24 mm	6.5	Interpump 44, 60, 63, E2
Engine Speed 3400 RPM for Small Frame Engines SAE J609-A Flange 2.3:1 Gear Ratio					

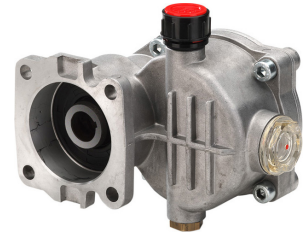

B18H GEAR REDUCER

Part No.	Description	RPM	Pump Shaft	Max HP	For Pump Series
50000000	1" Input Shaft	1450	24 mm	18	Interpump 47, 47HT, 47SS, 66, 66HT, 66SS
Engine Speed 3400 RPM for Small Frame Engines SAE J609-A Flange 2.2:1 Gear Ratio					
Gear Reducer for HONDA Engines / Honda Approved					

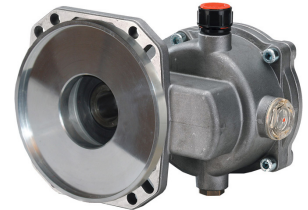

RS500 & RS500H GEAR REDUCER

Part No.	Description	RPM	Pump Shaft	Max HP	For Pump Series
RS500	1" Input Shaft	1650	24 mm	25	Interpump 47, 47HT, 47SS, 66, 66HT, 66SS, E3
RS500H*	1" Input Shaft				
RS500-28.6	1-1/8" Input Shaft				
RS500 Replaces RS151					
*H=Gear Reducer for HONDA Engines / Honda Approved					
Engine Speed 3400 RPM for Large Frame Engines SAE J609-B Flange 2.2:1 Gear Ratio					



B24/B31 GEAR REDUCER

Part No.	Description	RPM	Pump Shaft	Max HP	For Pump Series
50006200P	1" Input Shaft	1650	24 mm	24	Interpump 47, 47HT, 47SS, 66, 66HT, 66SS, E3
50007100P	1-1/8" Input Shaft			31	
Engine Speed 3400 RPM for Large Frame Engines SAE J609-A Flange 2.2:1 Gear Ratio					

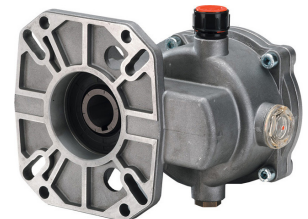

TOOL KIT

Part No.
TKI

- Interpump Pump Service Tool Kit
- Heavy Duty Shop Service



INSERTION TOOL KIT

Part No.
ZMVTOOL

- Packing Insertion Tool Kit (Included in TKI)
- Contains Inserting Tools for Installing 20 mm, 22 mm & 24 mm V Packings in the Packing Gland
- Prevents Damaged Sealing Services



EXTRACTION TOOL KIT

Part No.
PULLKIT

- Light Duty Packing Extractor Tool Kit with Extractor Colletes from 13 mm to 24 mm



SLIDE HAMMER

Part No.
26019400I

- Extractor Colletes Slide Hammer (Included in TKI)



PUMP RAILS

Part No.	Description
ZFEET59H22	For Series 59
ZFEET68H34	For Series 68, 76, 77, 70
ZFEET70H46	For Series 70
ZFEET71H26	For Series 71
ZFEET47H30	For Series 47, 66



Part No.	Description
EVORAILKIT	For Series E2, E3



OIL DRAIN KIT

Part No.	Description
ODK250	1/4" Fits Series 44, 47, 50, 51, 60, 63, 66
ODK375	3/8" Fits Series 69, 70, 76, 77
ODK500	1/2" Fits Series 71

- 4 Foot Hose to Aid with Oil Disposal
- Screw in Cap to Eliminate Drips
- Full Flow Oil Drain Valve
- Knob Designed to Prevent Accidental Operation



INLET CHECK VALVE SEAT REMOVAL TOOL

Part No.	Description
27513700I	For Series HF16-18
27513500I	For Series HF20-22-25
27513400I	Alignment Rod for all above (Not Included)



Part No.	Description
27516200I	For Series MW, MK, MKS 40-45-50, LK36-40-45
27516300I	For Series MK, MKS 55-60-65, LK 50-55-60



PUMP REPAIR KIT SELECTION GUIDE

JB Part No.	GP Part No.	Series	PG	Piston Oil Seal	Packing Kit	Ceramic	Valve Caps	Plunger Bolts	Head Rings	Crank Oil Seal	Check Valve Kit	LP & HP Seal Kit
Kits Requires Per Pump (Unless Otherwise Specified)				1	3	3	1	1	1	1	1	1
W950BAV		44	73	RKI130	RKI130	52040009I	RKI124	N/A	N/A	90169000I	RKI123	RKI088
W950BH		44	73	RKI023	RKI130	52040009I	RKI124	N/A	N/A	90169000I	RKI123	RKI088
W953BAV		44	73	RKI023	RKI130	52040009I	RKI124	N/A	N/A	90169000I	RKI123	RKI088
W953BH		44	73	RKI023	RKI130	52040009I	RKI124	N/A	N/A	90169000I	RKI123	RKI088
W956B	EZ2536S	44	73	RKI023	RKI131	44040109I	RKI124	N/A	N/A	90164100I	RKI123	RKI127
W956BAV	EZ2536EUI	44	73	RKI023	RKI131	44040109I	RKI124	N/A	N/A	90169000I	RKI123	RKI127
W956BH	EZ2536E	44	73	RKI023	RKI131	44040109I	RKI124	N/A	N/A	90169000I	RKI123	RKI127
W959B	EZ2542S	44	73	RKI023	RKI131	44040109I	RKI124	N/A	N/A	90164100I	RKI123	RKI127
W959BAV		44	73	RKI023	RKI131	44040109I	RKI124	N/A	N/A	90169000I	RKI123	RKI127
W959BH	EZ2542E	44	73	RKI023	RKI131	44040109I	RKI124	N/A	N/A	90169000I	RKI123	RKI127
W953BV		44	73	RKI023	RKI130	52040009I	RKI124	N/A	N/A	90169000I	RKI123	RKI088
WW960BC	EZ3035G	44	73	RKI023	RKI130	52040009I	RKI124	N/A	N/A	90169000I	RKI123	RKI088
WW960BCV	EZ3035GUK	44	73	RKI023	RKI130	52040009I	RKI124	N/A	N/A	90169000I	RKI123	RKI088
WW961BC	EZ3040G	44	73	RKI023	RKI130	52040009I	RKI124	N/A	N/A	90169000I	RKI123	RKI088
WW961BCV	EZ3040GUI	44	73	RKI023	RKI130	52040009I	RKI124	N/A	N/A	90169000I	RKI123	RKI088
WW962BC	EZ3045G	44	73	RKI023	RKI130	52040009I	RKI124	N/A	N/A	90169000I	RKI123	RKI088
WW962BCV	EZ2545GUI	44	73	RKI023	RKI130	52040009I	RKI124	N/A	N/A	90169000I	RKI123	RKI088
WW963BC	EZ4030G34	44	73	RKI023	RKI156	44040266I	RKI158	N/A	N/A	90169000I	RKI123	RKI153
WW963BC	EZ4030G34	44	73	RKI023	RKI156	44040266I	RKI158	N/A	N/A	90169000I	RKI123	RKI153
WW964BC	EZ4035G34	44	73	RKI023	RKI156	44040266I	RKI158	N/A	N/A	90169000I	RKI123	RKI153
WW965B		44	73	RKI023	RKI156	44040266I	RKI158	N/A	N/A	90164100I	RKI123	RKI153
WW965BC	EZ4040G	44	73	RKI023	RKI156	44040266I	RKI158	N/A	N/A	90169000I	RKI123	RKI153
T1011B	T1011	47	75	RKI002	RKI028	47040409I	RKI004	RKI006	RKI007	RKI003	RKI001	RKI069
T1311B		47	75	RKI002	RKI028	47040409I	RKI004	RKI006	RKI007	RKI003	RKI001	RKI069
T1321B	T1321	47	75	RKI002	RKI029	47040509I	RKI004	RKI006	RKI011	RKI003	RKI001	RKI148
T1511B	T1511	47	75	RKI002	RKI028	47040409I	RKI004	RKI006	RKI007	RKI003	RKI001	RKI069
T1621BN	T1621	47	75	RKI002	RKI029	47040509I	RKI005	RKI006	RKI011	RKI003	RKI001	RKI148
T2011BN	T2011	47	75	RKI002	RKI028	47040409I	RKI005	RKI006	RKI007	RKI003	RKI001	RKI069
T5050B	T5050	47	75	RKI002	RKI151	47040856I	N/A	RKI107	RKI108	RKI003	RKI150	RKI109
T9211B	T9211	47	75	RKI002	RKI028	47040409I	RKI005	RKI006	RKI007	RKI003	RKI001	RKI069
T921B	T921	47	75	RKI002	RKI029	47040509I	RKI004	RKI006	RKI011	RKI003	RKI001	RKI148
T9281B	T9281	47	75	RKI002	RKI112	47040856I	RKI106	RKI107	RKI108	RKI003	RKI001	RKI109
TS1011B	TS1011	47	75	RKI002	RKI028	47040409I	RKI004	RKI006	RKI007	RKI003	RKI001	RKI069
TS1021BN	TS1021	47	75	RKI002	RKI028	47040409I	RKI004	RKI006	RKI007	RKI003	RKI001	RKI069
TS1321BN	TS1321	47	75	RKI002	RKI029	47040509I	RKI004	RKI006	RKI011	RKI003	RKI001	RKI148
TS1331B	TS1331	47	75	RKI002	RKI028	47040409I	RKI004	RKI006	RKI007	RKI003	RKI001	RKI069
TS1511B	TS1511	47	75	RKI002	RKI028	47040409I	RKI004	RKI006	RKI007	RKI003	RKI001	RKI069
TS1621BN	TS1621	47	75	RKI002	RKI029	47040509I	RKI005	RKI006	RKI011	RKI003	RKI001	RKI148
TS1711B	TS1711	47	75	RKI002	RKI028	47040409I	RKI004	RKI006	RKI007	RKI003	RKI001	RKI069
TS2011BN	TS2011	47	75	RKI002	RKI028	47040409I	RKI005	RKI006	RKI007	RKI003	RKI001	RKI069
TS2021BN	TS2021	47	75	RKI002	RKI028	47040409I	RKI005	RKI006	RKI007	RKI003	RKI001	RKI069
TS821B	TS821	47	75	RKI002	RKI028	47040409I	RKI004	RKI006	RKI007	RKI003	RKI001	RKI069
TS921B	TS921	47	75	RKI002	RKI029	47040509I	RKI004	RKI006	RKI011	RKI003	RKI001	RKI148
T1631B	T1631	48	75	RKI024 (2)	RKI029(2)	47040509I	RKI004	RKI006 (2)	RKI011	90167000I	RKI001 (2)	RKI148(2)
T2031B	T2031	48		RKI024 (2)	RKI028(2)	47040409I	RKI004	RKI006 (2)	RKI007	90167000I	RKI001 (2)	RKI069(2)
TS1351B	TS1351	48		RKI024 (2)	RKI028	47040409I	RKI004	RKI006 (2)	RKI007	90167000I	RKI001 (2)	RKI069(2)
T721B	T721B	49		RKI023	RKI027	50040409I	RKI004	RKI006	RKI021	90163400I	RKI001	RKI019
T731B	T731B	49		RKI023	RKI027	50040409I	RKI004	RKI006	RKI021	90163400I	RKI001	RKI019
T9711BA	T9711EBF	49		RKI023	RKI027	50040409I	RKI004	RKI006	RKI021	90163400I	RKI001	RKI019
T9721B	T9721B	49		RKI023	RKI027	50040409I	RKI004	RKI006	RKI021	90163400I	RKI001	RKI019
T9721BA (RS)	T9721EBF	49		RKI023	RKI027	50040409I	RKI004	RKI006	RKI021	90163400I	RKI001	RKI019
T9731B	T9721EBF	49		RKI023	RKI027	50040409I	RKI004	RKI006	RKI021	90163400I	RKI001	RKI019
T9731BA	T9731EBF	49		RKI023	RKI027	50040409I	RKI004	RKI006	RKI021	90163400I	RKI001	RKI019
T9791B	T9791B	49		RKI023	RKI027	50040409I	RKI004	RKI006	RKI021	90163400I	RKI001	RKI019

DISCOD

PUMP REPAIR KIT SELECTION GUIDE

JB Part No.	GP Part No.	Series	PG	Piston Oil Seal	Packing Kit	Ceramic	Valve Caps	Plunger Bolts	Head Rings	Crank Oil Seal	Check Valve Kit	LP & HP Seal Kit
Kits Requires Per Pump (Unless Otherwise Specified)				1	3	3	1	1	1	1	1	1
T911B	T911	50	DISCOD	RKI023	RKI027	50040409I	RKI004	RKI006	RKI021	90163400I	RKI001	RKI019
T991B	T991	50		RKI023	RKI027	50040409I	RKI004	RKI006	RKI021	90163400I	RKI001	RKI019
T9951B	T9951	50		RKI023	RKI027	50040409I	RKI004	RKI006	RKI021	90163400I	RKI001	RKI019
T9961B	T9961	50		RKI023	RKI027	50040409I	RKI004	RKI006	RKI021	90163400I	RKI001	RKI019
T9971B	T9971	50		RKI023	RKI027	50040409I	RKI004	RKI006	RKI021	90163400I	RKI001	RKI019
TT9351B	TT9351	50		RKI023	RKI092	50040409I	RKI004	N/A	RKI090	90163400I	RKI001	RKI088
TT9441B	TT9441B	50		RKI023	RKI092	52040009I	RKI004	N/A	RKI090	90163400I	RKI001	RKI088
T9051BA	T9051EBF	51	71	RKI083	RKI096	51040009I	RKI084	N/A	51100051I	90164400I	RKI001	RKI097
T9051BAV	T9051EBFUI	51	71	RKI083	RKI096	51040009I	RKI084	N/A	51100051I	90164400I	RKI001	RKI097
TT1505BA	TT1505EBF	51	71	RKI083	RKI140	51040009I	RKI084	N/A	51100051I	90164400I	RKI001	RKI141
TT1540BC	TT1540GBF	51	71	RKI083	RKI096	51040009I	RKI084	N/A	51100051I	90164400I	RKI001	RKI097
TT2021BA	TT2021EBF	51	71	RKI083	RKI096	51040009I	RKI084	N/A	51100051I	90164400I	RKI001	RKI097
TT2028BA	TT2028EBF	51	71	RKI083	RKI096	51040009I	RKI084	N/A	51100051I	90164400I	RKI001	RKI097
TT2028BC	TT2028GBF	51	71	RKI083	RKI096	51040009I	RKI084	N/A	51100051I	90164400I	RKI001	RKI097
TT2530BA (RS)	TP2530J34	51	71	RKI083	RKI096	51040009I	RKI157	N/A	51100051I	90164400I	RKI001	RKI097
TT2530BAV (RS)	TP2530J34UIL	51	71	RKI083	RKI096	51040009I	RKI157	N/A	51100051I	90164400I	RKI001	RKI097
TT2530BC (RS)	TP2530J34	51	71	RKI083	RKI096	51040009I	RKI157	N/A	51100051I	90164400I	RKI001	RKI097
TT2530BCV (RS)	TP2530J34UIL	51	71	RKI083	RKI096	51040009I	RKI157	N/A	51100051I	90164400I	RKI001	RKI097
TT901B	TT901	51	71	RKI083	RKI096	51040009I	RKI084	N/A	51100051I	90164400I	RKI001	RKI097
TT9061BA	TT9061EBF	51	71	RKI083	RKI096	51040009I	RKI084	N/A	51100051I	90164400I	RKI001	RKI097
TT9061BAV	TT9061EBFUI	51	71	RKI083	RKI096	51040009I	RKI084	N/A	51100051I	90164400I	RKI001	RKI097
TT9061BC	TT9061GBF	51	71	RKI083	RKI096	51040009I	RKI084	N/A	51100051I	90164400I	RKI001	RKI097
TT9061BCV	TT9061GBFUI	51	71	RKI083	RKI096	51040009I	RKI084	N/A	51100051I	90164400I	RKI001	RKI097
TT9071BA	TT9071EBF	51	71	RKI083	RKI096	51040009I	RKI084	N/A	51100051I	90164400I	RKI001	RKI097
TT9071BAV	TT9071EBFUI	51	71	RKI083	RKI096	51040009I	RKI084	N/A	51100051I	90164400I	RKI001	RKI097
TT9071BC (RS)	TT9071GBF	51	71	RKI083	RKI096	51040009I	RKI084	N/A	51100051I	90164400I	RKI001	RKI097
TT9071BCV (RS)	TT9071GBFUI	51	71	RKI083	RKI096	51040009I	RKI084	N/A	51100051I	90164400I	RKI001	RKI097
TT9091BA (RS)	TT2035EBF	51	71	RKI083	RKI096	51040009I	RKI084	N/A	51100051I	90164400I	RKI001	RKI097
TT9091BAV	TT2035EBFUI	51	71	RKI083	RKI096	51040009I	RKI084	N/A	51100051I	90164400I	RKI001	RKI097
TT9091BC (RS)	TT2035GBF	51	71	RKI083	RKI096	51040009I	RKI084	N/A	51100051I	90164400I	RKI001	RKI097
TT9091BCV (RS)	TT9061GBF	51	71	RKI083	RKI096	51040009I	RKI084	N/A	51100051I	90164400I	RKI001	RKI097
TT9111B	TT9111	51	71	RKI083	RKI140	51040009I	RKI084	N/A	51100051I	90164400I	RKI001	RKI141
TT9111BA	TT9111EBF	51	71	RKI083	RKI140	51040009I	RKI084	N/A	51100051I	90164400I	RKI001	RKI141
TT931B	TT931	51	71	RKI083	RKI096	51040009I	RKI084	N/A	51100051I	90164400I	RKI001	RKI097
TT941B	TT941	51	71	RKI083	RKI096	51040009I	RKI084	N/A	51100051I	90164400I	RKI001	RKI097
TT951B	TT951	51	71	RKI083	RKI096	51040009I	RKI084	N/A	51100051I	90164400I	RKI001	RKI097
E1C1808A		56	70	RKI311	RKI312	53040009I	RKI310	99169000I	N/A	90167500I	RKI309	RKI313
E1E1812C		56	70	RKI311	RKI313	53040009I		99169000I	N/A	90167500I	RKI309	RKI312
E1E1808A		56	70	RKI311	RKI313	53040009I		99169000I	N/A	90167500I	RKI309	RKI312
E1E1813C		56	70	RKI311	RKI313	53040009I		99169000I	N/A	90167500I	RKI309	RKI312
E1E1811A		56	70	RKI311	RKI313	53040009I		99169000I	N/A	90167500I	RKI309	RKI312
E1E1812CSV		56	70	RKI311	RKI313	53040009I		99169000I	N/A	90167500I	RKI309	RKI312
E1C1808AV		56	70	RKI311	RKI313	53040009I		99169000I	N/A	90167500I	RKI309	RKI312
E1E1808AV		56	70	RKI311	RKI313	53040009I		99169000I	N/A	90167500I	RKI309	RKI312
E1E1811AV		56	70	RKI311	RKI313	53040009I		99169000I	N/A	90167500I	RKI309	RKI312
E1C1612A		56	70	RKI311	RKI315	63040509I		99169000I	N/A	90167500I	RKI309	RKI315
E2C1715S		58	72	RKI271	RKI277	58040209I	RKI270	99169000I	N/A	90164100I	RKI269	RKI274
E2E2815C1H		58	72	RKI271	RKI275	58040009I	RKI270	99169000I	N/A	90169000I	RKI269	RKI272
E2E2113		58	72	RKI271	RKI276	58040009I	RKI270	99169000I	N/A	90169000I	RKI269	RKI272
E2C2111A		58	72	RKI271	RKI276	58040009I	RKI270	99169000I	N/A	90169000I	RKI269	RKI272
E2E2815C1		58	72	RKI271	RKI275	58040009I	RKI270	99169000I	N/A	90169000I	RKI269	RKI272
E2E2815C1HRS		58	72	RKI271	RKI275	58040009I	RKI270	99169000I	N/A	90169000I	RKI269	RKI272
E2C1714A		58	72	RKI271	RKI277	58040209I	RKI270	99169000I	N/A	90169000I	RKI269	RKI274
E3E2520C1		59	74	RKI271	RKI288	58040109I	RKI292	99169000I	N/A	90164800I	RKI269	RKI283

PUMP REPAIR KIT SELECTION GUIDE

JB Part No.	GP Part No.	Series	PG	Piston Oil Seal	Packing Kit	Ceramic	Valve Caps	Plunger Bolts	Head Rings	Crank Oil Seal	Check Valve Kit	LP & HP Seal Kit
Kits Requires Per Pump (Unless Otherwise Specified)				1	3	3	1	1	1	1	1	1
E3C2515		59	74	RKI271	RKI290	59040009I	RKI292	99169000I	N/A	90164800I	RKI269	RKI285
E3C2515RS		59	74	RKI271	RKI290	59040009I	RKI292	99169000I	N/A	90164800I	RKI269	RKI285
E3B1515		59	74	RKI271	RKI290	59040009I	RKI292	99169000I	N/A	90164800I	RKI269	RKI285
E3B2515		59	74	RKI271	RKI290	59040009I	RKI292	99169000I	N/A	90164800I	RKI269	RKI285
E3B2118		59	74	RKI271	RKI291	59040109I	RKI292	99169000I	N/A	90164800I	RKI269	RKI286
E3B2121		59	74	RKI271	RKI291	59040109I	RKI292	99169000I	N/A	90164800I	RKI269	RKI286
UH1708C	TC1506G	60	DISCOD	RKI083	RKI226	60040009I	98221400I	N/A	51100051I	90169000I	RKI123	RKI196
UH1708CVH	TC1506GUI	60		RKI083	RKI226	60040009I	98221400I	N/A	51100051I	90169000I	RKI123	RKI196
UH1711C	TC1507G	60		RKI083	RKI226	60040009I	98221400I	N/A	51100051I	90169000I	RKI123	RKI196
UH1711CVH	TC1507GUI	60		RKI083	RKI226	60040009I	98221400I	N/A	51100051I	90169000I	RKI123	RKI196
UH1712C	TC1508G	60		RKI083	RKI226	60040009I	98221400I	N/A	51100051I	90169000I	RKI123	RKI196
UH1712CVH	TC1508GUI	60		RKI083	RKI226	60040009I	98221400I	N/A	51100051I	90169000I	RKI123	RKI196
UH1713C	TC1509G	60		RKI083	RKI226	60040009I	98221400I	N/A	51100051I	90169000I	RKI123	RKI196
UH1713CVH	TC1509GUI	60		RKI083	RKI226	60040009I	98221400I	N/A	51100051I	90169000I	RKI123	RKI196
UL1509A	TC1509E175	60		RKI083	RKI227	60040109I	98221400I	N/A	RKI197	90169000I	RKI123	RKI197
UL1512A	TC1809E175	60		RKI083	RKI227	60040109I	98221400I	N/A	RKI197	90169000I	RKI123	RKI197
UL1708A	TC1509E175	60		RKI083	RKI226	60040109I	98221400I	N/A	RKI196	90169000I	RKI123	RKI196
UH2011B		63		RKI159	RKI166	52040009I	RKI124	N/A	RKI162	90169000I	RKI123	RKI160
UH2011C	TX1506G6	63		RKI159	RKI166	52040009I	RKI124	N/A	RKI162	90169000I	RKI123	RKI160
UH2011C1	TX1506G8UI	63		RKI159	RKI166	52040009I	RKI124	N/A	RKI162	90169000I	RKI123	RKI160
UH2013B	TX1508S34	63		RKI159	RKI166	52040009I	RKI124	N/A	RKI162	90169000I	RKI123	RKI160
UH2013C	TX1508G6	63		RKI159	RKI166	52040009I	RKI124	N/A	RKI162	90169000I	RKI123	RKI160
UH2013C1	TX1508G8	63		RKI159	RKI166	52040009I	RKI124	N/A	RKI162	90169000I	RKI123	RKI160
UH2016B	TX1510S34	63		RKI159	RKI166	52040009I	RKI124	N/A	RKI162	90169000I	RKI123	RKI160
UH2016C	TX1510G6	63		RKI159	RKI166	52040009I	RKI124	N/A	RKI162	90169000I	RKI123	RKI160
UH2016C1	TX1510G8	63		RKI159	RKI166	52040009I	RKI124	N/A	RKI162	90169000I	RKI123	RKI160
UL1413A	TX1810E179	63	RKI159	RKI167	44040109I	RKI124	N/A	RKI163	90169000I	RKI123	RKI161	
UL1415A	TX1812E179	63	RKI159	RKI167	44040109I	RKI124	N/A	RKI163	90169000I	RKI123	RKI161	
UL1415B	TX1812S17	63	RKI159	RKI167	44040109I	RKI124	N/A	RKI163	90169000I	RKI123	RKI161	
UL2009A	TX1510E349	63	RKI159	RKI166	52040009I	RKI124	N/A	RKI162	90169000I	RKI123	RKI160	
UL2011A	TX1512E179	63	RKI159	RKI166	52040009I	RKI124	N/A	RKI162	90169000I	RKI123	RKI160	
T1750	TSF2421	66	76	RKI002	RKI182	66040409I	66130041I	66219566I	N/A	RKI003	RKI169	RKI181
T2040	TSF2221	66	76	RKI002	RKI173	66040109I	66130041I	66219566I	N/A	RKI003	RKI169	RKI172
T2535	TSF2021	66	76	RKI002	RKI171	66040009I	66130041I	66219566I	N/A	RKI003	RKI169	RKI170
T2535	TSF2219	66	76	RKI002	RKI171	66040009I	66130041I	66219566I	N/A	RKI003	RKI169	RKI170
T4018	TSP1621	66	76	RKI002	RKI175	66040209I	66130141I	66219566I	N/A	RKI003	RKI150	RKI174
W2030	TSF2219	66	76	RKI002	RKI173	66040109I	66130041I	66219566I	N/A	RKI003	RKI169	RKI172
W2035	TSF2221	66	76	RKI002	RKI173	66040109I	66130041I	66219566I	N/A	RKI003	RKI169	RKI172
W2141	TSF2421	66	76	RKI002	RKI182	66040409I	66130041I	66219566I	N/A	RKI003	RKI169	RKI181
W2525	TSF2019	66	76	RKI002	RKI171	66040009I	66130041I	66219566I	N/A	RKI003	RKI169	RKI170
W3521	TSP1819	66	76	RKI002	RKI176	66040309I	66130141I	66219566I	N/A	RKI003	RKI150	RKI180
W3523	TSP1821	66	76	RKI002	RKI176	66040309I	66130141I	66219566I	N/A	RKI003	RKI150	RKI180
W4015	TSP1619	66	76	RKI002	RKI175	66040209I	66130141I	66219566I	N/A	RKI003	RKI150	RKI174
W4018	TSP1621	66	76	RKI002	RKI175	66040209I	66130141I	66219566I	N/A	RKI003	RKI150	RKI174
W4518	TSP1621	66	76	RKI002	RKI175	66040209I	66130141I	66219566I	N/A	RKI003	RKI150	RKI174
W5015	TSP1619	66	76	RKI002	RKI175	66040209I	66130141I	66219566I	N/A	RKI003	RKI150	RKI174
T41AN	T41	69	DISCOD	RKI037	RKI039	69040009I	N/A	RKI074	RKI041	RKI032	RKI062	RKI038
TS1041B	TS1041	69		RKI037	RKI082	47040409I	98231200I	RKI054	RKI007	RKI032	RKI062	RKI069
TS1531B	TS1531	69		RKI037	RKI082	47040409I	98231200I	RKI054	RKI007	RKI032	RKI062	RKI069
T1551B	T1551	76		RKI044	RKI115	76040056I	98242000I	RKI074	RKI050	RKI032	RKI043	RKI113
T4251BN	T4251	76		RKI044	RKI078	61040056I	N/A	61219566I	RKI007	RKI032	RKI122	RKI077
T61ANB	T61	76		RKI044	RKI080	76040209I	98242000I	RKI074	RKI048	RKI032	RKI043	RKI079
T81ANB	T81	76		RKI044	RKI080	76040209I	98242000I	RKI074	RKI048	RKI032	RKI043	RKI079

PUMP REPAIR KIT SELECTION GUIDE

JB Part No.	GP Part No.	Series	PG	Piston Oil Seal	Packing Kit	Ceramic	Valve Caps	Plunger Bolts	Head Rings	Crank Oil Seal	Check Valve Kit	LP & HP Seal Kit
Kits Requires Per Pump (Unless Otherwise Specified)				1	3	3	1	1	1	1	1	1
T121ANB	T121	77	DISCOD	RKI044 (2)	RKI080	76040209I	98242000I	RKI074 (2)	RKI048	RKI032	RKI043 (2)	RKI079
T151ANB	T151	77		RKI044 (2)	RKI080	76040209I	98242000I	RKI074 (2)	RKI048	RKI032	RKI043 (2)	RKI079
T1591B	T1591	77		RKI044 (2)	RKI115(2)	76040056I	98242000I	RKI074 (2)	RKI065	RKI032	RKI043 (2)	RKI113(2)
ST1515	TS2012SS	47SS		RKI002	RKI239	47040409I	98223000I	47219766I	N/A	RKI003	RKI192	RKI238
ST1518		47SS		RKI002	RKI239	47040409I	98223000I	47219766I	N/A	RKI003	RKI192	RKI238
ST1521	TS2212SS	47SS		RKI002	RKI240	47040509I	98223000I	47219766I	N/A	RKI003	RKI192	RKI202
SW1513		47SS		RKI002	RKI239	47040409I	98223000I	47219766I	N/A	RKI003	RKI192	RKI238
SW1515	TS2012SS	47SS		RKI002	RKI239	47040409I	98223000I	47219766I	N/A	RKI003	RKI192	RKI238
SW1518	TS2212SS	47SS		RKI002	RKI240	47040509I	98223000I	47219766I	N/A	RKI003	RKI192	RKI202
SW1521	TS2016SS	47SS		RKI002	RKI239	47040409I	98223000I	47219766I	N/A	RKI003	RKI192	RKI238
SEL1411		63SS		RKI159	RKI216	44040109I	98222900I	N/A	N/A	90164100I	RKI192	RKI204
SEL1413		63SS		RKI159	RKI216	44040109I	98222900I	N/A	N/A	90164100I	RKI192	RKI204
SEL1414		63SS		RKI159	RKI216	44040109I	98222900I	N/A	N/A	90164100I	RKI192	RKI204
SEL1507		63SS		RKI159	RKI215	52040009I	98222900I	N/A	N/A	90164100I	RKI192	RKI214
SEL1509		63SS		RKI159	RKI215	52040009I	98222900I	N/A	N/A	90164100I	RKI192	RKI214
SUL1413	TX1510S17SS	63SS		RKI159	RKI216	44040109I	99130266I	66219666I	N/A	RKI003	RKI192	RKI204
SUL1415	TX1512S17SS	63SS		RKI159	RKI216	44040109I	99130266I	66219666I	N/A	RKI003	RKI192	RKI204
SUL1509	TX1810S17SS	63SS		RKI159	RKI215	52040009I	99130266I	66219666I	N/A	RKI003	RKI192	RKI214
SUL1511	TX1812S17SS	63SS		RKI159	RKI215	52040009I	99130266I	66219666I	N/A	RKI003	RKI192	RKI214
ST1530	TSF2021SS	66SS		RKI002	RKI217	66040009I	99130266I	66219666I	N/A	RKI003	RKI228	RKI206
ST1535	TSF2221SS	66SS		RKI002	RKI217	66040009I	99130266I	66219666I	N/A	RKI003	RKI228	RKI206
ST1540	TSF2421SS	66SS		RKI002	RKI218	66040109I	99130266I	66219666I	N/A	RKI003	RKI228	RKI208
ST1550		66SS		RKI002	RKI219	66040409I	99130266I	66219666I	N/A	RKI003	RKI228	RKI210
SW1525		66SS		RKI002	RKI217	66040009I	99130266I	66219666I	N/A	RKI003	RKI228	RKI206
SW1530		66SS		RKI002	RKI218	66040109I	99130266I	66219666I	N/A	RKI003	RKI228	RKI208
SW1535		66SS	RKI002	RKI218	66040109I	99130266I	66219666I	N/A	RKI003	RKI228	RKI208	
SW1541		66SS	RKI002	RKI219	66040409I	99130266I	66219666I	N/A	RKI003	RKI228	RKI210	
T111	AT0111	AG	RKI044 (2)	RKI080	76040209I	N/A	RKI074 (2)	RKI048	RKI032	RKI043 (2)	RKI079	
T111B		AG	RKI044 (2)	RKI080	76040209I	N/A	RKI074 (2)	RKI048	RKI032	RKI043 (2)	RKI079	
T177	AT0177	AG	RKI044 (2)	RKI080	76040209I	N/A	RKI074 (2)	RKI048	RKI032	RKI043 (2)	RKI079	
T177B	AT0177B	AG	RKI044 (2)	RKI080	76040209I	N/A	RKI074 (2)	RKI048	RKI032	RKI043 (2)	RKI079	
T33	AT0033	AG	RKI037	RKI039	69040009I	N/A	RKI074	RKI041	RKI033	RKI062	RKI038	
T3551BN	T3551	AG	RKI044 (2)	RKI078(2)	61040056I	N/A	61219566I	RKI007	RKI032	RKI122	RKI077(2)	
T44		AG	RKI037	RKI039	69040009I	N/A	RKI074	RKI041	RKI032	RKI062	RKI038	
T55	AT0055	AG	RKI037	RKI039	69040009I	N/A	RKI074	RKI041	RKI032	RKI062	RKI038	
T88	AT0088	AG	RKI044	RKI080	76040209I	N/A	RKI074	RKI048	RKI032	RKI043	RKI079	
T88B	AT0088B	AG	RKI044	RKI080	76040209I	N/A	RKI074	RKI048	RKI032	RKI043	RKI079	
CW1541	CW1541	CW	RKI044 (2)	100463(1)	69040009I	98242000I	RKI074	RKI041	RKI032	RKI043 (2)	RKI038(2)	
CW61	CW61	CW	RKI044	RKI080	69040009I	98242000I	RKI074	RKI048	RKI032	RKI043	RKI038(2)	
CW81	CW81	CW	RKI044	RKI080	69040009I	98242000I	RKI074	RKI048	RKI032	RKI043	RKI038(2)	
HT4715	HTS2210S	HT	81	RKI002	RKI203	47040509I	RKI005	RKI006	N/A	RKI003	RKI201	RKI202
HT4718	HTS2212S	HT	81	RKI002	RKI203	47040509I	RKI005	RKI006	N/A	RKI003	RKI201	RKI202
HT4721	HTS2016S	HT	81	RKI002	RKI203	47040509I	RKI005	RKI006	N/A	RKI003	RKI201	RKI202
HT4723	HTS2215S	HT	81	RKI002	RKI203	47040509I	RKI005	RKI006	N/A	RKI003	RKI201	RKI202
HT6007	HTC1505E345	HT	81	RKI083	RKI244	60040009I	98221300I	N/A	N/A	90163400I	RKI123	RKI243
HT6008	HTC1509E175	HT	81	RKI083	RKI244	60040009I	98221300I	N/A	N/A	90163400I	RKI123	RKI243
HT6311	HTX1810S	HT	DISCOD	RKI159	RKI205	63040509I	RKI158	N/A	N/A	90164100I	RKI123	RKI204
HT6313	HTX1812S	HT		RKI159	RKI205	63040509I	RKI158	N/A	N/A	90164100I	RKI123	RKI204
HT6315	HTX1813S	HT		RKI159	RKI205	63040509I	RKI158	N/A	N/A	90164100I	RKI123	RKI204
HT6628	HTF2018S	HT	81	RKI002	RKI207	66040009I	66130341I	66219566I	N/A	RKI003	RKI169	RKI206
HT6639	HTF2221S	HT	81	RKI002	RKI209	66040109I	66130341I	66219566I	N/A	RKI003	RKI169	RKI208
HT6646	HTF2421S	HT	81	RKI002	RKI211	66040409I	66130341I	66219566I	N/A	RKI003	RKI169	RKI210
HT6968	HTW3624S	HT	81	RKI037	RKI213	69040009I	98242100I	69219666I	N/A	RKI032	RKI043	RKI212
HT7095	HTCK3623S	HT	81	90167700I	RKI2032	70040509I	N/A	70224111I	N/A	90166800I	RKI2030	RKI2031

PUMP REPAIR KIT SELECTION GUIDE

JB Part No.	GP Part No.	Series	PG	Piston Oil Seal	Packing Kit	Ceramic	Valve Caps	Plunger Bolts	Head Rings	Crank Oil Seal	Check Valve Kit	LP & HP Seal Kit
Kits Requires Per Pump (Unless Otherwise Specified)				1	3	3	1	1	1	1	1	1
HT71150	HTCK4050S	HT	81	90167800I	RKI2034	71040509I	N/A	71219566I	N/A	90170000I	KIT2012IPR & KIT2013IPR	RKI2033
W12070H		70	77	90167700I	N/A	70040409I	N/A	70224136I	70100451I	90166800I	RKI2030	RKI2010
W100100H		70	77	90167700I	N/A	70040509I	N/A	70224136I	71100251I	90166800I	RKI2030	RKI2133
WK155	WK155	70	77	90167700I	N/A	70040409I	N/A	70224136I	70100451I	90166800I	RKI2246 & RKI2247	RKI2010
WK6	WK6	70	77	90167700I	N/A	70041309I	N/A	70224136I	72100051I	90166800I	RKI2246 & RKI2247	RKI2248
WK8	WK8	70	77	90167700I	N/A	70040509I	N/A	70224136I	71100251I	90166800I	RKI2246 & RKI2248	RKI2254
WK525		70	77	90167700I	N/A	70041009I	N/A	70224136I	47100351I	90166800I	RKI2031 & RKI2256	RKI2227
WK530	WK530	70	77	90167700I	N/A	70041109I	N/A	70224136I	71100051I	90166800I	RKI2031 & RKI2257	RKI2228
WK159	WK159	71	77	90167800I	N/A	71040309I	N/A	71219566I	70100451I	90170000I	RKI2012 & RKI2013	RKI2016
WK12	WK12	71	77	90167800I	N/A	71040409I	N/A	71219566I	72100051I	90170000I	RKI2012 & RKI2014	RKI2066
WK15	WK15	71	77	90167800I	N/A	72040009I	N/A	71219566I	71100251I	90170000I	RKI2012 & RKI2015	RKI2018
WK355	WK355	71	77	90167800I	N/A	71040109I	N/A	71219566I	70100151I	90170000I	RKI2022 & RKI2023	RKI2026
AB80	AB80	70	78	RKI297	N/A	71040409I	N/A	71219566I	71100251I	90167200I	RKI295 & RKI296	RKI299
AB90	AB90	70	78	RKI297	N/A	71040409I	N/A	71219566I	71100251I	90167200I	RKI295 & RKI296	RKI299
AB100	AB100	70	78	RKI297	N/A	71040509I	N/A	71219566I	71100351I	90167200I	RKI295 & RKI296	RKI300
AB110	AB110	70	78	RKI297	N/A	71040509I	N/A	71219566I	71100351I	90167200I	RKI295 & RKI296	RKI300
AB120	AB120	70	78	RKI297	N/A	68040009I	N/A	71219566I	68100051I	90167200I	RKI295 & RKI296	RKI301
AB140	AB140	70	78	RKI297	N/A	68040009I	N/A	71219566I	68100051I	90167200I	RKI295 & RKI296	RKI301
AB150	AB150	70	78	RKI297	N/A	68040109I	N/A	71219566I	761000251I	90167200I	RKI295 & RKI296	RKI302
AB180	AB180	70	78	RKI297	N/A	68040109I	N/A	71219566I	761000251I	90167200I	RKI295 & RKI296	RKI302
C2W2011	C2W2011	CW	80	RKI271	RKI342	58040209I	RKI292	99169000I	66100351I	90164100I	RKI269	RKI343
C2W2012	C2W2012	CW	80	RKI271	RKI342	58040209I	RKI292	99169000I	66100351I	90164100I	RKI269	RKI343
C2W2013	C2W2013	CW	80	RKI271	RKI342	58040209I	RKI292	99169000I	66100351I	90164100I	RKI269	RKI343
C3W2015	C3W2015	CW	80	RKI271	RKI345	59040009I	RKI292	99169000I	66100351I	90164100I	RKI269	RKI344
C3W2021	C3W2021	CW	80	RKI271	RKI347	59040109I	RKI292	99169000I	66100951I	90164800I	RKI269	RKI346
C3W2013HT	C3W2013HT	CW	80	RKI271	RKI409	59040009I	RKI292	99169000I	66100951I	90164800I	RKI269	RKI350
C3W2015HT	C3W2015HT	CW	80	RKI271	RKI409	59040009I	RKI292	99169000I	66100951I	90164800I	RKI269	RKI350
C3W2021HT	C3W2021HT	CW	80	RKI271	RKI409	59040009I	RKI292	99169000I	66100951I	90164800I	RKI269	RKI350

- Premium Quality SKF Crankshaft Bearings
- Nickel Plate Spheroidal Cast Iron Pump Head
- New Plunger Fastening System
- Re-Designed High and Low Packing System
- Temperatures up to 140°F
- Oversized Oil Sight Glass
- Optimized Inlet/Delivery Valve
- Inlet Pressures up to 125 PSI

NEMA 56 C-FRAME ELECTRIC MOTOR - HOLLOW SHAFT PUMP

Part No.	GPM	PSI	RPM	Bore	Stroke	BHP
E1C1808A	2.11	2,610	1,750	15 mm	9 mm	3.8
E1C1609A	2.38	2,320		18 mm	10 mm	3.8
E1C1612A	3.17	2,320		18 mm	13 mm	5.0
E1E1808A	2.11	2,610	3,400	15 mm	4.5 mm	3.8
E1E1811A	2.91	2,610		15 mm	6 mm	5.2
E1E1812A	3.17	2,610		15 mm	6.5 mm	5.7

- Inlet Port Thread: 1/2" BSP-F
- Discharge Port Thread: 3/8" BSP-F
- Oil Capacity: 8.5 fl oz
- Shaft Diameter: 5/8" Hollow Shaft
- Pump Dimensions: 7.42" x 7.71" x 3.84"
- Weight: 11 lbs



SAE J 609-A GASOLINE ENGINE - HOLLOW SHAFT PUMP

Part No.	GPM	PSI	RPM	Bore	Stroke	GHP
E1E1808C	2.11	2,610	3,400	15 mm	4.5 mm	5.0
E1E1811C	2.91	2,610		15 mm	6 mm	6.9
E1E1812C	3.17	2,610		15 mm	6.5 mm	7.5
E1E1813C	3.43	2,610		15 mm	7 mm	8.1

- Inlet Port Thread: 1/2" BSP-F
- Discharge Port Thread: 3/8" BSP-F
- Oil Capacity: 8.5 fl oz
- Shaft Diameter: 3/4" Hollow Shaft
- Pump Dimensions: 7.42" x 7.71" x 3.84"
- Weight: 11 lbs



NEMA 56 C-FRAME ELECTRIC MOTOR - HOLLOW SHAFT PUMP WITH BUILT-IN UNLOADER

Part No.	GPM	PSI	RPM	Bore	Stroke	BHP
E1C1808AV	2.11	2,610	1,750	15 mm	9 mm	3.8
E1C1609AV	2.38	2,320		18 mm	10 mm	3.8
E1C1612AV	3.17	2,320		18 mm	13 mm	5.0
E1E1808AV	2.11	2,610	3,400	15 mm	4.5 mm	3.8
E1E1811AV	2.91	2,610		15 mm	6 mm	5.2
*E1E1812ARS-3/4	3.17	2,610		15 mm	6.5 mm	5.7
*E1E1813AV	3.43	2,610		15 mm	7 mm	6.1

- Inlet Port Thread: 1/2" BSP-F
- Discharge Port Thread: 3/8" BSP-F
- Oil Capacity: 8.5 fl oz
- Shaft Diameter: 5/8" Hollow Shaft
- *Shaft Diameter: 3/4" Hollow Shaft
- Pump Dimensions: 10" x 7.36" x 8.36"
- Weight: 11 lbs



SAE J 609-A GASOLINE ENGINE - HOLLOW SHAFT PUMP WITH BUILT-IN UNLOADER

Part No.	GPM	PSI	RPM	Bore	Stroke	GHP
E1E1808CV	2.11	2,610	3,400	15 mm	4.5 mm	5.0
E1E1811CV	2.91	2,610		15 mm	6 mm	6.9
E1E1812CV	3.17	2,610		15 mm	6.5 mm	7.5
E1E1813CV	3.43	2,610		15 mm	7 mm	8.1

- Inlet Port Thread: 1/2" BSP-F
- Discharge Port Thread: 3/8" BSP-F
- Oil Capacity: 8.5 fl oz
- Shaft Diameter: 3/4" Hollow Shaft
- Pump Dimensions: 8.24" x 9.58" x 7.16"
- Weight: 11 lbs



51 SERIES TRIPLEX PLUNGER PUMPS

- Premium Quality Crankshaft Bearings
- 6 Post High Temperature Plastic Valve Cages
- Inlet Pressures up to 125 PSI
- Re-Designed High and Low Packing System
- Temperatures up to 140°F
- Forged Brass Pump Head

NEMA 56 C-FRAME ELECTRIC MOTOR - HOLLOW SHAFT PUMP

Part No.	GPM	PSI	RPM	Bore	Stroke	BHP	Shaft Type
TT1505BA	0.5	1,500	1750	18 mm	2 mm	0.5	5/8"
T9051BA	2.11	1,500		15 mm	9.4 mm	2.2	5/8"
TT9111BA	3	1,500		18 mm	9.4 mm	3.1	5/8"
T1212ARS	3.17	1750	3400	15mm	13mm	4	5/8"
TT2021BA	2.1	2,000		15 mm	5 mm	2.9	5/8"
TT9061BA	2.11	1,500		15 mm	5 mm	2.2	5/8"
TT2028BA	2.8	2,000		15 mm	6.6 mm	3.8	5/8"
TT9071BA	2.8	1,500		15 mm	6.6 mm	2.9	5/8"
TT2530BA	2.88	2,500		15 mm	7.2 mm	4.9	3/4"
TT2530BARS	2.88	2,500		15 mm	7.2 mm	4.9	3/4"
TT9091BA	3.5	2,000		15 mm	8 mm	4.8	3/4"
TT9091BARS	3.5	2,000		15 mm	8 mm	4.8	3/4"



- Inlet Port Thread: 3/8" BSP-F
- Discharge Port Thread: 1/4" BSP-F
- Oil Capacity: 11.2 fl oz
- Pump Dimensions: 7.2" x 7.2" x 5.5"
- Weight: 11.5 lbs

RS - Reverse Shaft

NEMA 56 C-FRAME ELECTRIC MOTOR - HOLLOW SHAFT PUMP WITH BUILT-IN UNLOADER

Part No.	GPM	PSI	RPM	Bore	Stroke	BHP	Shaft Type
T9051BAV	2.1	1,500	1,750	15 mm	9.4 mm	2.2	5/8"
T1212AVRS	3.17	1750		15mm	13mm	4	5/8"
TT9061BAV	2.1	1,500	3,400	15 mm	5 mm	2.2	5/8"
TT9071BAV	2.8	1,500		15 mm	6.6 mm	2.9	5/8"
TT2530BAV	2.88	2,500		15 mm	7.2 mm	4.9	3/4"
TT9091BAV	3.5	2,000		15 mm	8 mm	4.8	3/4"

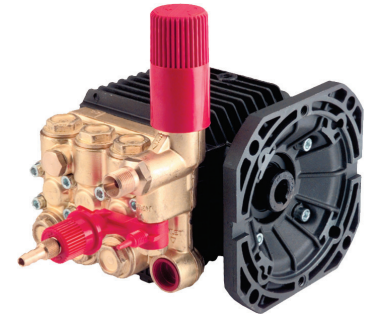

- Inlet Port Thread: 1/2" BSP-F
- Discharge Port Thread: 3/8" BSP-F
- Oil Capacity: 11.2 fl oz
- Pump Dimensions: 7.2" x 7.2" x 5.5"
- Weight: 11.5 lbs

SAE J 609-A GASOLINE ENGINE - HOLLOW SHAFT PUMP

Part No.	GPM	PSI	RPM	Bore	Stroke	GHP	Shaft Type
TT9061BC	2.11	1,500	3,400	15 mm	5 mm	2.9	3/4"
TT2028BC	2.8	2,000		15 mm	6.6 mm	5.1	3/4"
TT9071BC	2.8	1,500		15 mm	6.6 mm	3.8	3/4"
TT2530BC	2.88	2,500		15 mm	7.2 mm	6.5	3/4"
TT9091BC	3.5	2,000		15 mm	8 mm	6.4	3/4"



- Inlet Port Thread: 3/8" BSP-F
- Discharge Port Thread: 1/4" BSP-F
- Oil Capacity: 11.2 fl oz
- Pump Dimensions: 7.2" x 7.2" x 5.5"
- Weight: 11.5 lbs

SAE J 609-A GASOLINE FLANGE - HOLLOW SHAFT PUMP WITH BUILT-IN UNLOADER

Part No.	GPM	PSI	RPM	Bore	Stroke	GHP	Shaft Type
TT9061BCV	2.11	1,500	3,400	15 mm	5 mm	2.9	3/4"
TT9071BCV	2.8	1,500		15 mm	6.6 mm	3.8	3/4"
TT2530BCV	2.88	2,500		15 mm	7.2 mm	6.5	3/4"
TT2530BCVRS	2.88	2,500		15 mm	7.2 mm	6.5	3/4"
TT9091BCVRS	3.5	2,000		15 mm	8 mm	6.4	3/4"



- Inlet Port Thread: 3/8" BSP-F
- Discharge Port Thread: 1/4" BSP-F
- Oil Capacity: 11.2 fl oz
- Pump Dimensions: 7.2" x 7.2" x 5.5"
- Weight: 11.5 lbs

RS - Reverse Shaft

- Premium Quality SKF Crankshaft Bearings
- Forged Brass Pump Head
- New Plunger Fastening System
- Re-Designed High and Low Packing System
- For Temperatures up to 140°F
- Oversized Oil Sight Glass
- Optimized Inlet/Delivery Valve
- Inlet Pressures up to 125 PSI

24 MM SOLID SHAFT PUMPS

Part No.	GPM	PSI	RPM	Bore	Stroke	BHP
E2C2109	2.39	3,045	1,750	15 mm	10 mm	5.0
E2C2111	2.9	3,045		15 mm	12 mm	6.0
E2C2112	3.17	3,045		15 mm	13 mm	6.6
E2C1713	3.43	2,465		18 mm	9 mm	5.8
E2C1714	3.69	2,465		18 mm	10 mm	6.2
E2C1715	3.96	2,465		18 mm	11 mm	6.7
E2C2016	4.22	2,900		18 mm	12 mm	8.4
E2C2809	2.38	4,000		15 mm	10 mm	6.5



- Inlet Port Thread: 1/2" BSP-F
- Discharge Port Thread: 3/8" BSP-F
- Oil Capacity: 8.5 fl oz
- Pump Dimensions: 7.42" x 7.71" x 3.84"
- Weight: 15.4 lbs

HOLLOW SHAFT VERSION 1 1/8" - NEMA 184TC ELECTRIC FLANGE

Part No.	GPM	PSI	RPM	Bore	Stroke	BHP
E2C2109A	2.38	3,045	1,750	15 mm	10 mm	5.0
E2C2111A	2.9	3,045		15 mm	12 mm	6.0
E2C1713A	3.43	2,465		18 mm	9 mm	5.8
E2C1714A	3.69	2,465		18 mm	10 mm	6.2
E2C2015A	4.0	3,000		18 mm	11 mm	6.7



- Inlet Port Thread: 1/2" BSP-F
- Discharge Port Thread: 3/8" BSP-F
- Oil Capacity: 8.5 fl oz
- Pump Dimensions: 7.42" x 7.71" x 3.84"
- Weight: 15.4 lbs

HOLLOW SHAFT VERSION 1" SAE J609 GASOLINE ENGINE

Part No.	GPM	PSI	RPM	Bore	Stroke	GHP
E2E2111C1	2.91	3,045	3,400	15 mm	6 mm	8.1
E2E2113C1	3.46	3,045		15 mm	7 mm	9.6
E2E2116C1	4.22	3,045		15 mm	9 mm	11.7
E2E2808C1	2.11	4,000		13 mm	6 mm	7.7
E2E2810C1	2.64	4,000		13 mm	7 mm	9.6
E2E2812C1	3.17	4,000		13 mm	9 mm	11.5
E2E2812C1	3.43	4,000		13 mm	10 mm	12.5
E2E2815C1	3.96	4,000		13 mm	8 mm	14.4



- Inlet Port Thread: 1/2" BSP-F
- Discharge Port Thread: 3/8" BSP-F
- Oil Capacity: 8.5 fl oz
- Pump Dimensions: 7.42" x 7.71" x 3.84"
- Weight: 15.4 lbs
- Add "H" to include Unloader Valve

44 SERIES TRIPLEX PLUNGER PUMPS

- Triplex Plunger Pumps
- Premium Quality SKF Crankshaft Bearings
- Self-Lubricated High and Low Packing System
- 6 Post Plastic Valve Cages
- Forged Brass Pump Head
- Temperatures up to 140°F
- Inlet Pressures up to 125 PSI
- 1/2" BSP-F Inlet Port Thread
- 3/8" BSP-F Discharge Port Thread
- 1.4 fl oz Oil Capacity
- 8.4" x 8.3" x 4.8" Pump Dimensions
- 18 lbs Weight

HOLLOW SHAFT VERSION 1 1/8" NEMA 184TC - ELECTRIC FLANGE

Part No.	GPM	PSI	RPM	Bore	Stroke	BHP
W950H	2.5	2,500	1,750	15 mm	11 mm	4.3
W953BH	3	3,000		15 mm	13 mm	6.2
W956BH	3.6	2,500		18 mm	11 mm	6.2
W14200H	3.6	2,900		18 mm	18 mm	7.2
W959BH	4.2	2,500		18 mm	13 mm	7.2

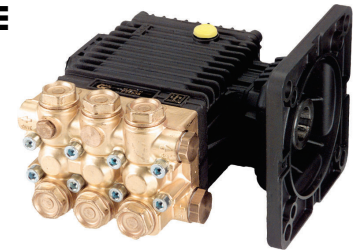

HOLLOW SHAFT VERSION 1 1/8" NEMA 184TC - ELECTRIC FLANGE WITH BUILT-IN VALVE

Part No.	GPM	PSI	RPM	Bore	Stroke	BHP
W950BAV	2.5	2,500	1,750	15 mm	11 mm	4.3
W953BAV	3	3,000		15 mm	13 mm	6.2
W956BAV	3.6	2,500		18 mm	11 mm	6.2
W959BAV	4.2	2,500		18 mm	13 mm	7.2



HOLLOW SHAFT VERSION 1" SAE J609-B GASOLINE ENGINE

Part No.	GPM	PSI	RPM	Bore	Stroke	GHP
WW966BC	3	4,000	3,400	13 mm	9.5 mm	10.9
WW967BC	3.5	4,000		15 mm	8.5 mm	12.7
WW960BC	3.5	3,000		13 mm	11 mm	9.5
WW968BC	4	4,000		15 mm	9.5 mm	14.5
WW961BC	4	3,000		13 mm	13 mm	10.9
WW962BC	4.6	3,000		15 mm	11 mm	12.5



HOLLOW SHAFT VERSION 1" SAE J609-B GASOLINE FLANGE WITH BUILT-IN VALVE

Part No.	GPM	PSI	RPM	Bore	Stroke	GHP
WW960BCV	3.5	3,000	3,400	15 mm	9.5 mm	9.5
WW960BCVRS	3.5	3,000		15 mm	8.5 mm	9.5
WW961BCV	4	3,000		15 mm	8.5 mm	10.9
WW961BCVRS	4	3,000		15 mm	9.5 mm	10.9
WW961BCVSP	4	3,500		15 mm	9.5 mm	12.7
WW962BCV	4.6	3,000		15 mm	11 mm	12.5

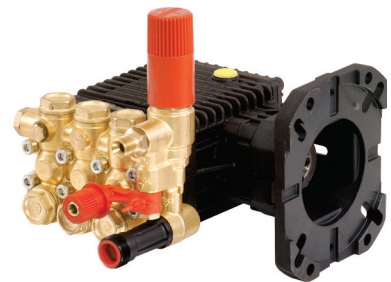

RS - Reverse Shaft

24 MM SOLID SHAFT VERSION

Part No.	GPM	PSI	RPM	Bore	Stroke	BHP
W953BV	3	2,500	1750	15 mm	13 mm	5.2
W956B	3.6	2,500		13 mm	13 mm	6.2
W14200BN	3.6	2,900		18 mm	18 mm	7.2
W959B	4.2	3,000	3,400	18 mm	13 mm	8.7
WW966B	3	4,000		13 mm	9.5 mm	8.3
WW967B	3.5	4,000		13 mm	11 mm	9.7
WW968B	4	4,000		18 mm	13 mm	11.0



RS - Reverse Shaft

EVOLUTION 3 SERIES TRIPLEX PLUNGER PUMPS

- Premium Quality SKF Crankshaft Bearings
- Re-Designed High and Low Packing System
- Optimized Inlet/Delivery Valve
- Forged Brass Pump Head
- For Temperatures up to 140°F
- Inlet Pressures up to 125 PSI
- New Plunger Fastening System
- Oversized Oil Sight Glass

EVOLUTION 3 STANDARD VERSION 24MM SHAFT

Part No.	GPM	PSI	RPM	Bore	Stroke	BHP
E3A1713B	3.43	2,465	1,000	22 mm	11 mm	5.8
E3A2113BN	3.43	3,045		22 mm	11 mm	7.2
E3A1515B	3.83	2,175		22 mm	12 mm	5.7
E3A2115BN	3.83	3,045		22 mm	12 mm	8.0
E3B1911B	2.91	2,755	1,450	18 mm	10 mm	5.5
E3B2511BN	2.91	3,625		18 mm	10 mm	7.2
E3B1713B	3.43	2,465		20 mm	10 mm	5.8
E3B2513BN	3.43	3,625		20 mm	10 mm	8.5
E3B2515BN	3.96	3,625		20 mm	11 mm	9.8
E3B1515B	4.76	2,175		20 mm	13 mm	7.1
E3B1218B	4.76	1,750		22 mm	11 mm	5.7
E3B2118BN	4.76	3,045		22 mm	13 mm	9.9
E3B1021B	5.5	1,450	1,750	22 mm	13 mm	5.5
E3B2121BN	5.55	3,045		22 mm	13 mm	11.6
E3C1713B	3.43	2,465		18 mm	10 mm	5.8
E3C2513BN	3.43	3,625		18 mm	10 mm	8.5
E3C1515B	3.96	2,175		20 mm	9.6 mm	5.9
E3C2515BN	3.96	3,625		20 mm	9.6 mm	9.8
E3C2518BN	4.49	3,625		20 mm	11 mm	11.1
E3C1218B	4.76	1,750		20 mm	11 mm	5.7
E3C1021B	5.55	1,450	1,750	20 mm	13 mm	5.5
E3C2521BN	5.55	3,625		20 mm	13 mm	13.8

- Inlet Port Thread: 1/2" BSP-F
- Discharge Port Thread: 3/8" BSP-F
- Oil Capacity: 8.5 fl oz
- Pump Dimensions: 10.4" x 8.8" x 5.4"
- Weight: 21 lbs



HOLLOW SHAFT VERSION 1" SAE J609-B GASOLINE ENGINE

Part No.	GPM	PSI	RPM	Bore	Stroke	GHP
E3E2813BNC1	3.43	4,000	3,400	13 mm	9.6 mm	12.5
E3E2815BNC1	3.96	4,000		13 mm	11 mm	14.4
E3E2517BNC1	4.49	3,625		15 mm	9.6 mm	14.8
E3E2520BNC1	5.28	3,625		15 mm	11 mm	17.4

- Inlet Port Thread: 1/2" BSP-F
- Discharge Port Thread: 3/8" BSP-F
- Oil Capacity: 8.5 fl oz
- Pump Dimensions: 10.4" x 8.8" x 5.4"
- Weight: 21 lbs



HOLLOW SHAFT HYDRAULIC FLANGE SAE J744-A 7/8" KEYED SHAFT

Part No.	GPM	PSI	RPM	Bore	Stroke	BHP
E3B2515I	3.96	3,625	1,450	20 mm	11 mm	9.8
	5.28	3,625	1,950			13.1
E3B2121I	5.55	3,045	1,450	22 mm	13 mm	11.6

- Inlet Port Thread: 1/2" BSP-F
- Discharge Port Thread: 3/8" BSP-F
- Oil Capacity: 8.5 fl oz
- Pump Dimensions: 10.4" x 8.8" x 5.4"
- Weight: 21 lbs



47 SERIES TRIPLEX PLUNGER PUMPS

- Solid Shaft, Heavy-Duty Brass or Nickel Plated Pump Head
- Solid Ceramic Plungers
- Self-Lubricated High and Low Packing System
- Premium Quality Tapered Roller Bearings
- Oversized Connecting Rods, Non-Elastic Crankshaft with Hardened Connecting Rod Journals

47 SERIES TRIPLEX PLUNGER PUMPS

Part No.	GPM	PSI	RPM	Bore	Stroke	BHP	
T1621BN	5	2,500	1,050	22 mm	16 mm	8.6	
T921B*	5	1,700		22 mm	16 mm	5.8	
T2011BN*	4.5	3,000	1,125	20 mm	16 mm	10.8	
T1311B*	4.5	2,200		20 mm	16 mm	6.6	
T1321B*	5.5	2,100	1,150	22 mm	16 mm	7.9	
TS1711B	3.5	2,700	1,450	20 mm	10 mm	7.2	
TS1511B	4	3,500		20 mm	12 mm	9.6	
TS1621BN*	4.75	2,500		22 mm	12 mm	8.2	
TS1321B	4.75	2,100		22 mm	12 mm	6.8	
TS921B	4.75	1,800		22 mm	12 mm	5.9	
TS821B	5.55	1,450		20 mm	12 mm	5	
TS2021BN	5.6	3,500		20 mm	16 mm	13.5	
TS1021B	5.6	1,700		20 mm	16 mm	6.5	
T1011B*	5.6	1,500		20 mm	16 mm	5.5	
WS1630	7.92	2,300		22 mm	19 mm	12	
**WS1036	9.51	1,450		28 mm	14 mm	9.4	
**WS1040	10.56	1,450		28 mm	16 mm	10.5	
W928	3.96	4,000		1,750	16 mm	16 mm	11
T9281B	4	4,000			16 mm	16 mm	11
T9211B	4	3,000			20 mm	10 mm	8.2
TS1331B	4.2	2,000	20 mm		10 mm	5.8	
TS2011BN	4.75	3,000	20 mm		10 mm	9.8	
TS1011B	4.75	1,500	20 mm		12 mm	5.5	
W922BN	5.55	2,900	20 mm		12 mm	10	
W914B	5.55	1,450	20 mm		13 mm	5.5	
**TS1044	11.62	1,450	28 mm		14 mm	11.5	
**TS1050	13.21	1,450	28 mm		16 mm	13.1	
T5050B	5	5,000	1,845	16 mm	19 mm	17.2	

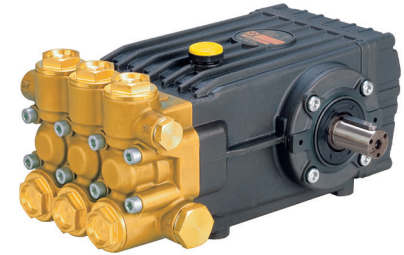

**NEW!
NEW!**

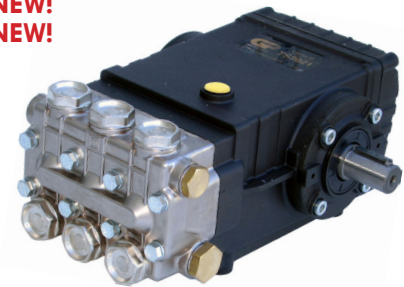

**NEW!
NEW!**

- Inlet Port Thread: 1/2" BSP-F
- Discharge Port Thread: 3/8" BSP-F
- Oil Capacity: 40 fl oz
- Shaft Diameter: 24 mm
- ** Inlet Port Thread: 3/4" BSP-F
- ** Discharge Port Thread: 3/8" BSP-F
- Pump Dimensions: 12.2" x 9.2" x 6.9"
- Weight: 33 lbs

***Drive Shaft Extension on Both Sides of Pump**

- Solid Shaft, Heavy-Duty Brass Pump Head
- Solid Ceramic Plungers
- Self-Lubricated High and Low Packing System
- Premium Quality Roller Bearings
- Oversized Connecting Rods, Non-Elastic Crankshaft with Hardened Connecting Rod Journals

66 SERIES LOW PRESSURE TRIPLEX PLUNGER PUMPS

Part No.	GPM	PSI	RPM	Bore	Stroke	BHP
W3021	5.55	4,350	1,450	18 mm	19 mm	16.5
W2525	6.6	3,625		20 mm	19 mm	16.4
W3025	6.6	4,350		20 mm	19 mm	19.7
W2030	7.92	2,900		22 mm	19 mm	15.7
W2035	9.25	2,900		22 mm	21 mm	18.4
W2141	10.83	3,045		24 mm	21 mm	22.6
W1550	13.2	2,175		28 mm	19 mm	19.7
*W1570	18.56	2,175	31 mm	21 mm	27.6	
T3025	6.6	4,350	1,750	18 mm	19 mm	19.7
T2530	7.92	3,625		20 mm	19 mm	19.7
T2830	7.92	4,000		20 mm	19 mm	21.7
T2535	9.25	3,600		22 mm	19 mm	23.0
T2040	10.56	2,900		22 mm	21 mm	21.0
T1750	13.2	2,500		24 mm	21 mm	22.6

- Inlet Port Thread: 3/4" BSP-F
- Discharge Port Thread: 3/8" BSP-F
- Shaft Diameter: 24 mm
- 165°F Max Water Inlet Temperature
- Oil Capacity: 31.4 fl oz
- * Inlet Port Thread: 1" BSP-F
- * Discharge Port Thread: 1/2" BSP-F
- Pump Dimensions: 13.2" x 9.6" x 6.23"
- Weight: 41 lbs



66 SERIES HIGH PRESSURE TRIPLEX PLUNGER PUMPS

Part No.	GPM	PSI	RPM	Bore	Stroke	BHP
W5015	3.96	7,520	1,450	19 mm	16 mm	20.4
W4015	3.96	5,800		19 mm	16 mm	15.7
W4518	4.75	6,225		21 mm	16 mm	20.3
W5018	4.75	7,250		16 mm	21 mm	23.6
W4018	4.8	5,800		16 mm	21 mm	19.1
W3521	5.6	5,075		18 mm	19 mm	19.5
*WK5021	5.55	7,250	18 mm	19 mm	27.6	
W3523	6.1	5,075	21 mm	18 mm	21.2	
T4018	4.75	5,800	1,750	19 mm	16 mm	18.9
T5018	4.75	7,250		16 mm	19 mm	23.6

- Inlet Port Thread: 1/2" BSP-F
- Discharge Port Thread: 3/8" BSP-F
- Shaft Diameter: 24 mm
- 165°F Max Water Inlet Temperature
- Oil Capacity: 31.4 fl oz
- Pump Dimensions: 13.2" x 9.6" x 6.23"
- Weight: 52 lbs

* AISI 420 SS Pump Head



HOLLOW SHAFT HYDRAULIC FLANGE SAE J744-A 5/8" KEYED SHAFT

Part No.	GPM	PSI	RPM	Bore	Stroke	BHP
T2535SPF	9.25	3,600	1,750	22 mm	19 mm	20.4
T2040SPF	10.56	2,900		22 mm	21 mm	15.7
T1750SPF	13.2	2,500	1,450	24 mm	21 mm	20.3
W1555SPF	14.63	2,030		28 mm	21 mm	23.6



- Solid Shaft, Heavy-Duty Brass or Nickel Plated Pump Head
- Solid Ceramic Plungers
- Self-Lubricated High and Low Packing System
- Premium Quality Tapered Roller Bearings
- Oversized Connecting Rods, Non-Elastic Crankshaft with Hardened Connecting Rod Journals
- Water Temperature Up To 140°F

W100100H NICKEL PLATED BRASS PUMP HEAD

Part No.	GPM	PSI	RPM	Bore	Stroke	BHP
W12070H	18.5	1,750	1,450	30 mm	26 mm	22.2
W100100H	26.4	1,450		32 mm	26 mm	16.3

- Inlet Port Thread: 1" BSP-F
- Discharge Port Thread: 1/2" BSP-F
- Shaft Diameter: 30 mm
- Oil Capacity: 68 fl oz
- Pump Dimensions: 13.6" x 13.4" x 8.6"
- Weight: 81 lbs



NICKEL PLATED CAST IRON PUMP HEAD

Part No.	GPM	PSI	RPM	Bore	Stroke	BHP
WK155	14.5	2,175	1,000	30 mm	26 mm	21.6
WK6	16.4	1,450		32 mm	26 mm	16.3
WK8	21.1	1,450		36 mm	26 mm	21.0

- Inlet Port Thread: 1 1/4" BSP-F
- Discharge Port Thread: 1" BSP-F
- Shaft Diameter: 30 mm
- Oil Capacity: 64 fl oz
- Pump Dimensions: 13.6" x 13.4" x 8.6"
- Weight: 84 lbs



NICKEL PLATED AISI420 PUMP HEAD

Part No.	GPM	PSI	RPM	Bore	Stroke	BHP
WK525	5.8	7,250	1,450	30 mm	26 mm	28.8
WK530	7.7	7,250		32 mm	26 mm	38.2

- Inlet Port Thread: 1" BSP-F
- Discharge Port Thread: 1/2" BSP-F
- Shaft Diameter: 30 mm
- Oil Capacity: 68 fl oz
- Pump Dimensions: 13.6" x 13.4" x 8.6"
- Weight: 84 lbs



NICKEL PLATED CAST IRON PUMP HEAD

Part No.	GPM	PSI	RPM	Bore	Stroke	BHP
WK159	28	2,175	1,000	30 mm	50 mm	41.7
WK12	31.7	1,740		32 mm	50 mm	37.8
WK15	39.61	1,740		36 mm	50 mm	47.2

- Inlet Port Thread: 1 1/2" BSP-F
- Discharge Port Thread: 1" BSP-F
- Shaft Diameter: 40 mm
- Oil Capacity: 128.5 fl oz
- Pump Dimensions: 13.6" x 13.4" x 8.6"
- Weight: 143 lbs



NICKEL PLATED AISI420 PUMP HEAD

Part No.	GPM	PSI	RPM	Bore	Stroke	BHP
WK355	15.1	5075	1000	22 mm	50 mm	52.5

- Inlet Port Thread: 1" BSP-F
- Discharge Port Thread: 3/4" BSP-F
- Shaft Diameter: 40 mm
- Oil Capacity: 128.5 fl oz
- Pump Dimensions: 13.6" x 13.4" x 8.6"
- Weight: 143 lbs



- Solid Shaft
- Solid Ceramic Plungers
- Self-Lubricated High and Low Packing System
- Premium Quality Roller Bearings
- Oversized Connecting Rods, Non-Elastic Crankshaft with Hardened Connecting Rod Journals
- Water Temperature Up To 140°F
- Dual Shaft Version

BRASS PUMP HEAD

Part No.	GPM	PSI	RPM	Bore	Stroke	BHP
AB80	19.8	870	550	36 mm	45 mm	11.8
AB90	23.8	870	650	36 mm	45 mm	14.2
AB100	26.4	870	550	40 mm	45 mm	15.7
AB110	29.1	870	650	40 mm	45 mm	17.3
AB120	31.7	870	550	45 mm	45 mm	18.9
AB140	37	870	650	45 mm	45 mm	22.0
AB150	39.6	870	550	50 mm	45 mm	23.6
AB180	47.6	870	650	50 mm	45 mm	28.4

- Inlet Port Thread: 1 1/2" BSP-F
- Discharge Port Thread: 1" BSP-F
- Shaft Diameter: 24 mm
- Oil Capacity: 88 fl oz
- Pump Dimensions: 18" x 14.2" x 9.6"
- Weight: 91 lbs

PUMP DESIGNATION:

CC - PTO - PTO

CL - PTO Left - 35mm Keyed Shaft Right

LC - PTO Right - 35mm Shaft Left



316L STAINLESS STEEL PUMPS

- Premium Quality SKF Crankshaft Bearings
- 6 Post High Temperature Plastic Valve Cages

- Inlet Pressure Up To 125 PSI
- 99% Alumina Ceramic Plungers

SS Standard Stainless Version

316L Stainless Steel Pump Head

Chemical Compatibility Version

HT (PTFE) Packings for Temperatures up to 185°F

SW Sea Water Version

316L Stainless Steel Pump Head

Standard Buna (NBR) Packings

SS1 SERIES PUMPS

SS Part No.	SW Part No.	GPM	PSI	RPM	Bore	Stroke	BHP
SS1B1505	SW1B1505	1.32	2,175	1,450	15 mm	7 mm	2.0
SS1B1507	SW1B1507	1.85	2,175		15 mm	9 mm	2.8
SS1B1509	SW1B1509	2.38	2,175		15 mm	12 mm	3.5
SS1B1511	SW1B1511	2.91	2,175		18 mm	10 mm	4.3
SS1B1513	SW1B1513	3.43	2,175		18 mm	12 mm	5.1
SS1B1514	SW1B1514	3.70	2,175		18 mm	13 mm	5.5
SS1C1509	SW1C1509	2.38	2,175	1,750	15 mm	10 mm	3.5
SS1C1511	SW1C1511	2.90	2,175		15 mm	12 mm	4.3
SS1C1513	SW1C1513	3.43	2,175		15 mm	10 mm	5.1
SS1C1515	SW1C1515	3.96	2,175		18 mm	12 mm	5.9



- Inlet Port Thread: 1/2" BSP-F
- Discharge Port Thread: 3/8" BSP-F
- Shaft Diameter: 24 mm
- Oil Capacity: 8.5 fl oz
- Pump Dimensions: 7.5" x 8.14" x 3.84"
- Weight: 13.2 lbs

SS3 SERIES PUMPS

SS Part No.	SW Part No.	GPM	PSI	RPM	Bore	Stroke	BHP
SS3B2013	N/A	3.43	2,900	1,450	20 mm	10 mm	6.8
SS3B2015	N/A	3.96	2,900		20 mm	12 mm	7.9
SS3B2018	N/A	4.76	2,900		22 mm	12 mm	7.1
SS3B2021	SW3B2021	5.55	2,900		22 mm	13 mm	11.0
SS3C2015	N/A	3.96	2,900	1,750	20 mm	10 mm	7.9
SS3C2018	N/A	4.76	2,900		20 mm	12 mm	9.4
SS3C2021	N/A	5.55	2,900		22 mm	12 mm	11.0

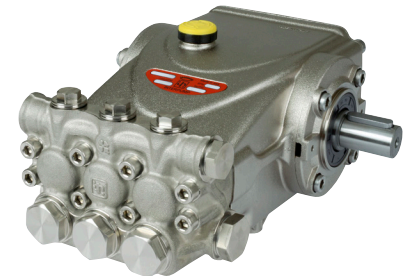

- Inlet Port Thread: 1/2" BSP-F
- Discharge Port Thread: 3/8" BSP-F
- Shaft Diameter: 24 mm
- Oil Capacity: 40 fl oz
- Pump Dimensions: 10.4" x 8.8" x 5.4"
- Weight: 23.9 lbs

66 SS SERIES PUMPS

SS Part No.	SW Part No.	GPM	PSI	RPM	Bore	Stroke	BHP
SSE2025	N/A	6.60	2,900	1,450	20 mm	18 mm	13.1
SSE2030	N/A	7.92	2,900		22 mm	18 mm	15.7
SSE2035	N/A	9.25	2,900		22 mm	21 mm	18.4
SSE2041	SWE2041	10.83	2,900		24 mm	23 mm	21.5
SSU2030	N/A	7.92	2,900	1,750	20 mm	18 mm	15.7
SSU2035	N/A	9.25	2,900		20 mm	21 mm	18.4
SSU2040	N/A	10.56	2,900		22 mm	20 mm	21.0
SSU2050	SWU2050	13.20	2,900		24 mm	21 mm	26.2

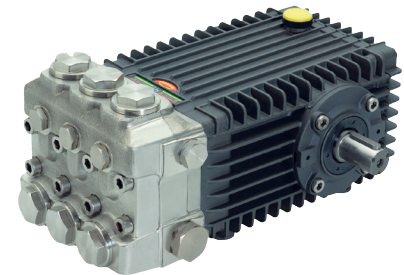

- Inlet Port Thread: 3/4" BSP-F
- Discharge Port Thread: 3/8" BSP-F
- Shaft Diameter: 24 mm
- Oil Capacity: 40.6 fl oz
- Pump Dimensions: 10.4" x 8.8" x 5.4"
- Weight: 46.3 lbs

NICKEL COATED 420SS PUMP HEAD AND ALUMINUM CRANKCASE

STANDARD BUNA (NBR) PACKINGS						
Part No.	GPM	PSI	RPM	Bore	Stroke	BHP
C2W2011	2.91	2,900	1,450	15 mm	12 mm	5.8
	3.43	2,900	1,750	15 mm	12 mm	6.8
C2W2012	3.17	2,900	1,450	18 mm	10 mm	6.3
	3.70	2,900	1,750	18 mm	10 mm	7.3
C2W2013	3.43	2,900	1,450	18 mm	11 mm	6.8
	3.96	2,900	1,750	18 mm	11 mm	7.9

- Inlet Port Thread: 1/2" BSP-F
- Discharge Port Thread: 3/8" BSP-F
- Shaft Diameter: 24 mm
- Oil Capacity: 8.5 fl oz
- Pump Dimensions: 7.42" x 7.71" x 3.84"
- Weight: 15.4 lbs

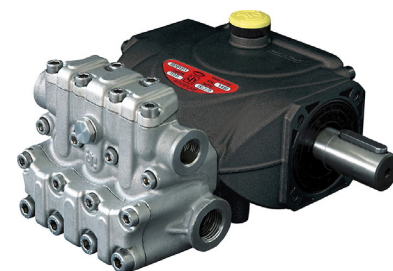

NICKEL COATED 420SS PUMP HEAD AND ALUMINUM CRANKCASE

STANDARD BUNA (NBR) PACKINGS						
Part No.	GPM	PSI	RPM	Bore	Stroke	BHP
C3W2013	3.43	2,900	1,450	20 mm	9.6 mm	6.8
	3.96	2,900	1,750	20 mm	9.6 mm	7.9
C3W2015	3.96	2,900	1,450	20 mm	11 mm	7.9
	4.76	2,900	1,750	20 mm	11 mm	9.5
C3W2021	3.43	2,900	950	20 mm	13 mm	6.8
	5.55	2,900	1,450	22 mm	13 mm	11.0

HT (PTFE) PACKINGS						
Part No.	GPM	PSI	RPM	Bore	Stroke	BHP
C3W2013HT	3.43	2,900	1,450	20 mm	9.6 mm	6.8
C3W2015HT	3.96	2,900		20 mm	11 mm	7.9
C3W2021HT	5.55	2,900		20 mm	13 mm	6.8

- Inlet Port Thread: 1/2" BSP-F
- Discharge Port Thread: 3/8" BSP-F
- Shaft Diameter: 24 mm
- Oil Capacity: 8.5 fl oz
- Pump Dimensions: 10.4" x 8.8" x 5.4"
- Weight: 21 lbs



Specially engineered pump for car wash applications (as shown to the left), with exceptional wear and corrosion resistance.

Now available with PTFE Packings to handle chemicals and water temperatures up to 185°F.

- Premium Quality SKF Crankshaft Bearings
- Re-Designed High and Low Packing System
- 6 Post High Temperature Plastic Valve Cages
- 99% Alumina Ceramic Plungers
- For Temperatures Up To 185°F
- Inlet Pressure Up To 125 PSI
- Extra Thick Nickel Plated Brass Pump Head

HT58 SERIES PUMPS

Part No.	GPM	PSI	RPM	Bore	Stroke	BHP
VHT5807	1.85	2,465	1,450	18 mm	6.5 mm	6.3
VHT5808	2.11	2,465		18 mm	7.5 mm	7.5
VHT5811	2.9	2,465		18 mm	10 mm	7.7
VHT5813	3.43	2,465		18 mm	12 mm	9.6
*VHT5815	3.96	2,465	1,750	18 mm	11 mm	5.5



VHT5815



- Inlet Port Thread: 1/2" BSP-F
- Discharge Port Thread: 3/8" BSP-F
- Oil Capacity: 8.5 fl oz
- Pump Dimensions: 10.4" x 8.8" x 5.4"
- Weight: 21 lbs

HT47 SERIES PUMPS

Part No.	GPM	PSI	RPM	Bore	Stroke	BHP
HT4715	3.96	2,320	1,450	22 mm	9 mm	6.3
HT4718	4.75	2,320		22 mm	11 mm	7.5
HT4721	5.55	2,030		22 mm	13 mm	7.7
HT4723	6.07	2,320		22 mm	14 mm	9.6



- Inlet Port Thread: 1/2" BSP-F
- Discharge Port Thread: 3/8" BSP-F
- Shaft Diameter: 24 mm
- Oil Capacity: 40 fl oz
- Pump Dimensions: 12.2" x 9.2" x 6.9"
- Weight: 32 lbs

HT66 SERIES PUMPS

Part No.	GPM	PSI	RPM	Bore	Stroke	BHP
HT6628	7.4	3,600	1,750	20 mm	17 mm	18.2
HT6639	10.3	2,900		22 mm	19 mm	20.5
HT6646	12.15	2,465		24 mm	21 mm	20.5
	10.04	2,900	24 mm	21 mm	19.9	
HT6650	13.2	2,175	1,450	28 mm	19 mm	19.9

NEW!



- Inlet Port Thread: 3/4" BSP-F
- Discharge Port Thread: 3/8" BSP-F
- Shaft Diameter: 24 mm
- Oil Capacity: 40.6 fl oz
- Pump Dimensions: 13.2" x 9.6" x 6.23"
- Weight: 40.8 lbs

HT70 SERIES PUMPS

Part No.	GPM	PSI	RPM	Bore	Stroke	BHP
HT7095	27	1,450	1,450	36 mm	23 mm	23.6

- Inlet Port Thread: 1" BSP-F
- Discharge Port Thread: 3/4" BSP-F
- Shaft Diameter: 30 mm
- Oil Capacity: 64.2 fl oz
- Pump Dimensions: 15.3" x 13.4" x 7.7"
- Weight: 79.6 lbs



HT71 SERIES PUMPS

Part No.	GPM	PSI	RPM	Bore	Stroke	BHP
HT71150	49.7	1,450	1,000	40 mm	50 mm	49.4

- Inlet Port Thread: 1-1/2" BSP-F
- Discharge Port Thread: 1" BSP-F
- Shaft Diameter: 40 mm
- Oil Capacity: 124.4 fl oz
- Pump Dimensions: 20.7" x 14.5" x 6.9"
- Weight: 157 lbs



- Piston Pumps
- For Pumping Mining Drilling Fluids
- Ceramic Sleeves
- Ball Type Check Valve

KT/KF TRIPLEX PISTON PUMP

Part No.	GPM	PSI	RPM*	Bore	Stroke	BHP
KT4M5B	19.6	750	600	45 mm	26 mm	10.0
KF5M9B	46.7	1,160	600	50 mm	50 mm	27

Nickel Plated Cast Iron Pump Head

- Inlet Port Thread: 1" NPT-F
- Discharge Port Thread: 1/2" NPT-F
- Shaft Diameter: 30 mm
- Oil Capacity: 68 fl oz
- Pump Dimensions: 15.2" x 14.4" x 11.2"
- Weight: 80 lbs

* Crankshaft Speed

Part No.	GPM	PSI	RPM*	Bore	Stroke	BHP
KF5M5B	46.7	750	600	50 mm	50 mm	24.0

Nickel Plated Cast Iron Pump Head

- Inlet Port Thread: 1 1/2" NPT-F
- Discharge Port Thread: 1" NPT-F
- Shaft Diameter: 40 mm
- Oil Capacity: 68 fl oz | 128.5 fl oz
- Pump Dimensions: 23" x 14.4" x 11.2"
- Weight: 158 lbs

* Crankshaft Speed



MW TRIPLEX PISTON PUMP

Part No.	GPM	PSI	RPM*	Bore	Stroke	BHP
MF7M5B	53.3	750	218	75 mm	70 mm	27.2

Nickel Plated Cast Iron Pump Head

- Inlet Port Thread: 66 mm Flanged Port
- Discharge Port Thread: 1 1/4" NPT-F
- Shaft Diameter: 50 mm
- Oil Capacity: 2.38 Gal
- Pump Dimensions: 29.5" x 23" x 14.5"
- Weight: 572 lbs

* Crankshaft Speed

**Gear Box Options: 4 Input Gear Ratios - 1,500 RPM, 1,800 RPM, 2,200 RPM, 2,600 RPM



MK2 TRIPLEX PISTON PUMP

Part No.	GPM	PSI	RPM*	Bore	Stroke	BHP
MK29M5B	105	750	290	90 mm	72 mm	51.0

Nickel Plated Cast Iron Pump Head

- Inlet Port Thread: 80 mm Flanged Port
- Discharge Port Thread: 1 1/4" NPT-F
- Shaft Diameter: 55 mm
- Oil Capacity: 3.5 Gal
- Pump Dimensions: 36.626" x 26.5" x 16"
- Weight: 897 lbs

* Crankshaft Speed

**Gear Box Options: 4 Input Gear Ratios - 1,500 RPM, 1,800 RPM, 2,200 RPM, 2,600 RPM



70 SERIES PUMPS

- Solid Shaft
- Solid Ceramic Plungers
- Self-Lubricated High and Low Packing System
- Premium Quality Roller Bearings
- Water Temperature Up To 140°F

KE SERIES

Standard 420SS	316L	420S	GPM	PSI	RPM	Bore	Stroke	BHP
KE20A	*SS7030	SN7030	7.8	4,350	1,450	20 mm	23 mm	24.7
KE22A	*SS7037	SN7037	9.8	3,650		22 mm	23 mm	25.3
KE24A	*SS7045	SN7045	11.9	3,050		24 mm	23 mm	25.1
KE28A	SS7061H	SN7061H	16.1	2,150		28 mm	23 mm	24.0
KE30A	SS7070H	SN7070H	18.5	1,850		30 mm	23 mm	23.8
KE36H	SS7091H	SN7091H	26.4	1,450		36 mm	23 mm	26.2

- Inlet Port Thread: 1" NPT-F
- Discharge Port Thread: 1/2" NPT-F
- Shaft Diameter: 30 mm
- Oil Capacity: 68 fl oz
- Pump Dimensions: 15" x 13.4" x 7.7"
- Weight: 80 lbs
- *Max Pressure: 2,900 PSI

KE SERIES - Clean Water, Nickel Coated, 420SS Pump Head

SS SERIES - Chemical Compatibility | 316SS Wet Components, HT Packings, Run Dry

SN SERIES - Clean Water, High Temp. Nickel Coated 420SS Pump Head



- Solid Shaft
- Self-Lubricated High and Low Packing System
- Water Temperature Up To 140°F
- Solid Ceramic Plungers
- Premium Quality Roller Bearings

EV SERIES - LOW PRESSURE VERSION

Part No.	GPM	PSI	RPM	Bore	Stroke	BHP
EV20A	12.6	3,625	1,450	20 mm	35 mm	38.0
	15.3	3,625	1,750	20 mm	35 mm	27.4
EV22A	15.3	2,610	1,450	22 mm	35 mm	27.4
	18.4	2,610	1,750	22 mm	35 mm	32.9
EV25A	19.8	2,175	1,450	25 mm	35 mm	29.5
	23.8	2,175	1,750	25 mm	35 mm	35.5
EV26A	21.4	1,885	1,450	26 mm	35 mm	27.6
	25.8	1,885	1,750	26 mm	35 mm	33.3
EV28A	24.8	1,740	1,450	36 mm	23 mm	29.6



- Inlet Port Thread: 1" NPT-F
- Discharge Port Thread: 1/2" NPT-F
- Shaft Diameter: 28 mm
- Oil Capacity: 64 fl oz
- Pump Dimensions: 17" x 12" x 7.75"
- Weight: 65 lbs

EV SERIES - Clean Water, HR Treated Cast Iron Pump Head

KT SERIES - HIGH PRESSURE VERSION

Part No.	GPM	PSI	RPM	Bore	Stroke	BHP
KT16A	7.2	7,250	1,750	16 mm	26 mm	35.8
KT19A	7.9	7,250	1,450	18 mm	26 mm	37.7
	9.5	5,800	1,750	18 mm	26 mm	39.2
KT20A	9.5	5,800	1,450	20 mm	26 mm	36.2
	11.4	4,640	1,750	20 mm	26 mm	37.7
KT22A	11.4	4,640	1,450	22 mm	26 mm	34.0
	13.7	3,625	1,750	22 mm	26 mm	36.2

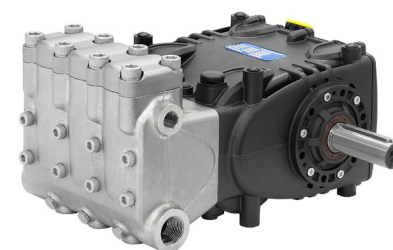

- Inlet Port Thread: 1" NPT-F
- Discharge Port Thread: 1/2" NPT-F
- Shaft Diameter: 30 mm
- Oil Capacity: 68fl oz
- Pump Dimensions: 16" x 13.4" x 7.5"
- Weight: 85 lbs

KT SERIES - Clean Water, Nickel Plated AISI420 Pump Head

KT SERIES - LOW PRESSURE VERSION

Part No.	GPM	PSI	RPM	Bore	Stroke	BHP
KT24A	13.5	3,625	1,450	24 mm	26 mm	32.4
	16.3	2,900	1,750	24 mm	26 mm	33.5
KT26A	15.8	3,625	1,450	26 mm	26 mm	39.2
KT28A	18.4	2,900	1,450	28 mm	26 mm	38.6
	22.2	2,538	1,750	28 mm	26 mm	36.5
KT30A	21.1	2,538	1,450	30 mm	26 mm	35.5
	25.5	2,030	1,750	30 mm	26 mm	36.7
KT32A	24.0	2,175	1,450	32 mm	26 mm	35.8
KT34A	27.2	2,175	1,450	34 mm	26 mm	40.5
KT36A	30.4	1,740	1,450	36 mm	26 mm	36.4
	36.7	1,450	1,750	36 mm	26 mm	36.2
KT40A	37.5	1,450	1,450	40 mm	26 mm	37.2



- Inlet Port Thread: 1 1/4" NPT-F
- Discharge Port Thread: 1" NPT-F
- Shaft Diameter: 30 mm
- Oil Capacity: 68fl oz
- Pump Dimensions: 15.5" x 13.4" x 8.3"
- Weight: 88 lbs

KT SERIES - Clean Water, HR Treated Cast Iron Pump Head

NOTE:
Add SPF to the end of any
70 Series Part Number
for SAE J744-B Hydraulic
Flange with 13T 16/32DP
Hollow Shaft Spline

- Solid Shaft
- Self-Lubricated High and Low Packing System
- Water Temperature Up To 140°F
- Solid Ceramic Plungers
- Premium Quality Roller Bearings

KF SERIES

Standard	R Packings	316L	420SS	GPM	PSI	RPM	Bore	Stroke	BHP
KF28A	KFR28A	SS7193A	SN7193A	24.4	3,045	1,000	28 mm	50 mm	50.9
KF30A	KFR30A	SS71106A	SN71106A	28.0	2,900	1,000	30 mm	50 mm	55.6
KF32A	KFR32A	N/A	N/A	31.7	2,610	1,000	32 mm	50 mm	56.7
KF36A	KFR36A	SS71153A	SN71153A	32.2	2,320	800	36mm	50mm	51.2
				36.2	2,050	900	36 mm	50 mm	50.8
				40.0	1,900	1,000	36 mm	50 mm	52.1
KF40A	KFR40A	SS71170A	SN71170A	45.0	1,600	900	40 mm	50 mm	49.3



- Inlet Port Thread: 1 1/2" NPT-F
- Discharge Port Thread: 1" NPT-F
- Shaft Diameter: 40 mm
- Oil Capacity: 68 fl oz | 128.5 fl oz
- Pump Dimensions: 20.7" x 14.4" x 10"
- Weight: 143 lbs

KF SERIES - Clean Water, Nickel Coated 420SS Pump Head

KFR SERIES - Run Dry High Temp, Nickel Coated 420SS Pump Head

SS SERIES - Chemical Compatibility | 316SS Wet Components, HT Packings, Run Dry

SN SERIES - Clean Water, High Temp.

HF SERIES

Standard 420SS	Block Style SS	GPM	PSI	RPM	Bore	Stroke	BHP
HF18A	N/A	8.1	8,700	800	18 mm	50 mm	48.3
		10.1	7,250	1,000	18 mm	50 mm	50.2
HF20A	N/A	12.4	5,800	1,000	20 mm	50 mm	49.3
HF22A	HFN22A	12.0	5,800	800	22 mm	50 mm	47.7
HF25A	HFN25A	19.4	4,060	1,000	25 mm	50 mm	53.9



HS SERIES

Standard 420SS	GPM	PSI	RPM	Bore	Stroke	BHP
HS18A	11.9	8,700	1,200	18 mm	50 mm	70.9
HS20A	14.8	7,250		20 mm	50 mm	73.5
HS22A	18.0	5,800		22 mm	50 mm	71.5



- Inlet Port Thread: 1" NPT-F
- Discharge Port Thread: 3/4" NPT-F
- Shaft Diameter: 40 mm
- Oil Capacity: 128.5 fl oz
- Pump Dimensions: 20" x 14.4" x 9.5"
- Weight: 143 lbs

HF SERIES - Clean Water, Nickel Coated 420SS Pump Head

HFN SERIES - Chemical Compatibility Duplex ASTM F51 Stainless Steel Block Style Pump Head

KS SERIES

Standard	R Packings	GPM	PSI	RPM	Bore	Stroke	BHP
KS28A	KSR28A	29.1	3,650	1,200*	28 mm	50 mm	72.8
KS32A	KSR32A	38.3	2,900		32 mm	50 mm	76.1
KS36A	KSR36A	48.3	2,320		36 mm	50 mm	77.7
KS38A	KSR38A	50	2,175		38 mm	50 mm	55
KS40A	KSR40A	59.7	2,030		40 mm	50 mm	81.8



- Inlet Port Thread: 2" NPT-F
- Discharge Port Thread: 1 1/2" NPT-F
- Shaft Diameter: 40 mm
- Oil Capacity without Gear Box: 149 fl oz
- Oil Capacity with Gear Box: 162 fl oz
- Pump Dimensions: 29" x 19" x 10.3"
- Weight: 209 lbs

*Pump Available with Gear Reducer Input Speed of 1,500 RPM, 1,800 RPM, 2,200 RPM

KS SERIES - Clean Water Pump, Nickel Coated 420SS Head

KSR SERIES - Run Dry, High Temp Pump, Nickel Coated 420SS Head

HY-PACK SERIES PUMPS

25 HP/35 HP - KE, KT, KV SERIES

Refer to Respective Pump Series for Detailed Pump Specs	
Standard SAE - B Hollow Shaft Pump with 13T 16/32DP Spline	
KE, KT, KV_HY47	Hydraulic Pack Pump with Opt 47 Gear Motor
KE, KT, KV_HY64	Hydraulic Pack Pump with Fox 64 Piston Motor

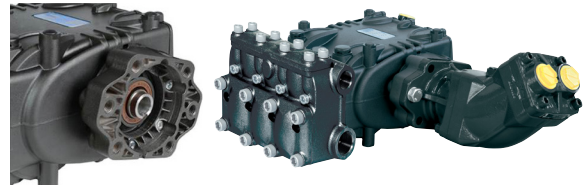

50 HP - KF, HF, VFH SERIES

Refer to Respective Pump Series for Detailed Pump Specs	
Standard SAE - C Hollow Shaft Pump with 14T 12/24DP Spline	
KF, HF, VFH_HY117	Hydraulic Pack Pump with Opt 117 Gear Motor
VFH_HY184	Hydraulic Pack Pump with Opt 184 Gear Motor
KF, HF_HY84	Hydraulic Pack Pump with Fox 84 Piston Motor
KF, HF, VFH_HY108	Hydraulic Pack Pump with Fox 108 piston Motor
VFH_HY130	Hydraulic Pack Pump with Fox 130 Piston Motor

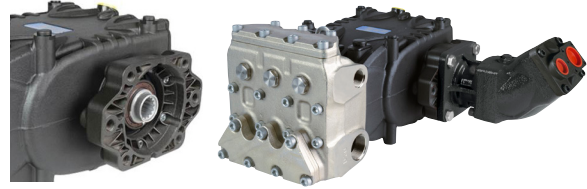

75 HP - KS, HS, VK SERIES

Refer to Respective Pump Series for Detailed Pump Specs	
Standard SAE - C Hollow Shaft Pump with 14T 12/24DP Spline	
KS, HS_HY117	Hydraulic Pack Pump with Opt 117 Gear Motor
KS, HS_HY184	Hydraulic Pack Pump with Opt 184 Gear Motor
KS, HS_HY108	Hydraulic Pack Pump with Fox 108 Piston Motor
KS, HS_HY130	Hydraulic Pack Pump with Fox 130 Piston Motor

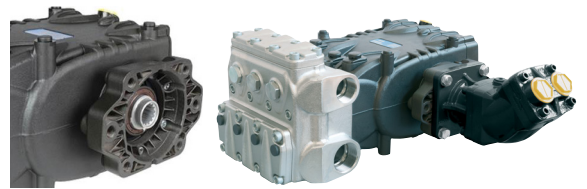

100 HP - MW, SM SERIES

Refer to Respective Pump Series for Detailed Pump Specs	
Standard SAE - C Hollow Shaft Pump with 14T 12/24DP Spline	
MW, SM_HY117	Hydraulic Pack Pump with Opt 117 Gear Motor
MW, SM_HY184	Hydraulic Pack Pump with Opt 184 Gear Motor
MW, SM_HY84	Hydraulic Pack Pump with Fox 84 Piston Motor
MW, SM_HY108	Hydraulic Pack Pump with Fox 108 Piston Motor
MW, SM_HY130	Hydraulic Pack Pump with Fox 130 Piston Motor

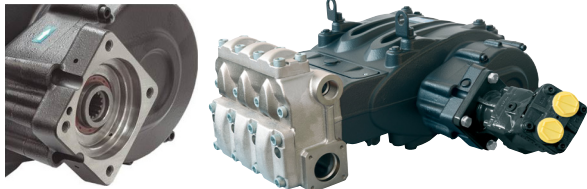

150-180 HP - MK, MKS SERIES

Refer to Respective Pump Series for Detailed Pump Specs	
Standard SAE - C Hollow Shaft Pump with 14T 12/24DP Spline	
MK, MKS_HY184	Hydraulic Pack Pump with Opt 184 Gear Motor
MK, MKS_HY108	Hydraulic Pack Pump with Fox 108 Piston Motor
MK, MKS_HY130	Hydraulic Pack Pump with Fox 130 Piston Motor



MUD PUMPS - KT, KF, MF, MK SERIES

Refer to Respective Pump Series for Detailed Pump Specs	
Standard SAE - B Hollow Shaft Pump with 13T 16/32DP Spline 100CC	
KT45HY100	Hydraulic Pack Pump with Orbital Motor
KF5MHY125	Hydraulic Pack Pump with White 125 Orbital Motor
KF5MHY200	Hydraulic Pack Pump with White 200 Orbital Motor
KF5MHY84	Hydraulic Pack Pump with Fox 84 Piston Motor
MF7MHY64	Hydraulic Pack Pump with Fox 64 Piston Motor
MF7MHY108	Hydraulic Pack Pump with Fox 108 Piston Motor
MK9MHY108	Hydraulic Pack Pump with Fox 108 Piston Motor
MK9MHY130	Hydraulic Pack Pump with Fox 130 Piston Motor



- Solid Shaft, Solid Ceramic Plungers
- Self-Lubricated High and Low Packing System
- Premium Quality Cylindrical Roller Bearings
- Oversized Connecting Rods, Non-Elastic Crankshaft with Rod Journals with Babbitt Bearings
- Temperature Up to 140°F

NOTE:
Add SPF to the end of any Part Number for SAE J744-C Hydraulic Flange with 14T 12/24DP Hollow Shaft Spline

MW SERIES

Standard	R Packings	Block Style SS	GPM	PSI	RPM	Bore	Stroke	BHP
MW32	MWR32	MWN32	35.9	4,350	1,500	32 mm	70 mm	107.0
MW36	MWR36	MWN36	45.4	3,500		36 mm	70 mm	108.8
MW40	MWR40	MWN40	56.3	2,750	1,800	40 mm	70 mm	106.0
MW45*	MWR45*	MWN45*	71.1	2,250	2,200	45 mm	70 mm	109.6
MW50*	MWR50*	MWN50*	88.0	1,800	2,600	50 mm	70 mm	108.5
MW55*	MWR55*	MWN55*	106.5	1,450		55 mm	70 mm	105.8

- Inlet Port Thread: 2" NPT-F
- Discharge Port Thread: 1" NPT-F
- Shaft Diameter: 50 mm
- Oil Capacity: 2.38 Gal
- ***Inlet Port Thread: 66 mm Flanged Port**
- ***Discharge Port Thread: 1 1/4" NPT-F**
- Pump Dimensions: 29.5" x 23" x 14.5"
- Weight: 572 lbs

**Gear Box Options: 4 Input Gear Ratios - 1,500 RPM, 1,800 RPM, 2,200 RPM, 2,600 RPM

MW SERIES - Clean Water, Nickel Plated Spheroidal Cast Iron Pump Head

MWR SERIES - Run Dry, High Temp, Nickel Plated Spheroidal Cast Iron Pump Head

MWN SERIES - Chemical Compatibility Duplex ASTM F51 Stainless Steel Block Style Pump Head



MF SERIES

Standard	R Packings	GPM	PSI	RPM	Bore	Stroke	BHP
MF45	MFR45	71	2,900	1,500	140 mm	70 mm	141.0
MF50	MFR50	88	2,465	1,800	1800 mm	70 mm	148.6
MF55	MFR55	106	2,030	2,600			

- Inlet Port Thread: 66 mm Flanged Port
- Discharge Port Thread: 1 1/4" NPT-F
- Shaft Diameter: 50 mm
- Oil Capacity: 2.38 Gal
- Pump Dimensions: 29.5" x 23" x 14.5"
- Weight: 573 lbs

**Gear Box Options: 4 Input Gear Ratios - 1,500 RPM, 1,800 RPM, 2,200 RPM, 2,600 RPM

MF SERIES - Clean Water, Nickel Plated Spheroidal Cast Iron Pump Head

MFR SERIES - Run Dry, High Temp, Nickel Plated Spheroidal Cast Iron Pump Head

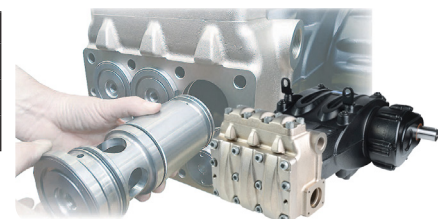

MK2 SERIES

Standard	R Packings	GPM	PSI	RPM	Bore	Stroke	BHP	
MK240	MK2R40	40.5	5,800	1,500	40 mm	72 mm	160.9	
MK245	MK2R45	51.2	4,350		45 mm	72 mm	152.5	
MK250	MK2R50	63.4	3,600		50 mm	72 mm	156.3	
MK255*	MK2R55*	76.7	2,900		1,800	55 mm	72 mm	152.3
MK260*	MK2R60*	91.4	2,500		60 mm	72 mm	156.5	
MK265*	MK2R65*	107.3	2,175	65 mm	72 mm	159.8		

- Inlet Port Thread: 2" NPT-F
- Discharge Port Thread: 1" NPT-F
- Shaft Diameter: 55 mm
- Oil Capacity: 3.5 Gal
- ***Inlet Port Thread: 80 mm Flanged Port**
- ***Discharge Port Thread: 1 1/4" NPT-F**
- Pump Dimensions: 36.626" x 26.5" x 16"
- Weight: 897 lbs

**Gear Box Options: 2 Input Gear Ratios - 1,500 RPM, 1,800 RPM

MK2 SERIES - Clean Water, Nickel Plated Spheroidal Cast Iron Pump Head

MK2R SERIES - Run Dry, High Temp, Nickel Plated Spheroidal Cast Iron Pump Head



MK2S SERIES

Standard	R Packings	GPM	PSI	RPM	Bore	Stroke	Weight	BHP
MK2S240	MK2SR40	48.4	5,800	1,500 1,800 2,200	40 mm	72 mm	866 lbs	192.3
MK2S245	MK2SR45	61.3	4,350		45 mm	72 mm	866 lbs	182.6
MK2S250	MK2SR50	75.8	3,600		50 mm	72 mm	866 lbs	186.9
MK2S255*	MK2SR55*	92.0	2,900		55 mm	72 mm	897 lbs	182.7
MK2S260*	MK2SR60*	109.5	2,500		60 mm	72 mm	897 lbs	187.5
MK2S265*	MK2SR65*	128.5	2,175		65 mm	72 mm	897 lbs	191.4

- Inlet Port Thread: 1" NPT-F
- Discharge Port Thread: 2" NPT-F
- Shaft Diameter: 55 mm
- Oil Capacity: 3.5 Gal
- *Inlet Port Thread: 80 mm Flanged Port
- *Discharge Port Thread: 1 1/4" NPT-F
- Pump Dimensions: 36.626" x 26.5" x 16"
- Weight: 897 lbs

**Gear Box Options: 3 Input Gear Ratios - 1,500 RPM, 1,800 RPM, 2,200 RPM

MKS2 SERIES - Clean Water, Nickel Plated Spheroidal Cast Iron Pump Head

MK2SR SERIES - Run Dry, High Temp, Nickel Plated Spheroidal Cast Iron Pump Head



- Solid Shaft
- Solid Ceramic Plungers
- Self-Lubricated High and Low Packing System
- Premium Quality Roller Bearings
- Water Temperature Up To 140°F

LK SERIES

Part No.	Part No.	GPM	PSI	RPM	Bore	Stroke	BHP
LK36	LKN36	37.0	5,800	1,500	36 mm	50 mm	147.0
		40.2	5,800	1,750	36 mm	50 mm	159.7
		40.7	5,800	1,900	36 mm	50 mm	161.7
LK40	LKN40	45.7	5,075	1,500	40 mm	50 mm	158.9
		49.7	5,075	1,750	40 mm	50 mm	172.8
		50.2	5,075	1,900	40 mm	50 mm	174.5
LK45	LKN45	57.6	4,060	1,500	45 mm	50 mm	160.2
		62.9	4,060	1,750	45 mm	50 mm	174.9
		63.7	4,060	1,900	45 mm	50 mm	177.1
LK50*	LKN50*	71.1	3,335	1,500	50 mm	50 mm	162.4
		77.7	3,335	1,750	50 mm	50 mm	177.5
		78.5	3,335	1,900	50 mm	50 mm	179.3
LK55*	LKN55*	86.1	2,755	1,500	55 mm	50 mm	162.5
		93.8	2,755	1,750	55 mm	50 mm	177.0
		95.1	2,755	1,900	55 mm	50 mm	179.5
LK60*	LKN60*	102.5	2,320	1,500	60 mm	50 mm	162.9
		111.8	2,320	1,750	60 mm	50 mm	177.7
		113.1	2,320	1,900	60 mm	50 mm	179.7

- Inlet Port Thread: 2" BSP-F
- Discharge Port Thread: 1" BSP-F
- Shaft Diameter: 50 mm
- Oil Capacity: 3.6 Gal
- *Inlet Port Thread: 80 mm Flanged Port
- *Discharge Port Thread: 36 mm Flanged Port
- Pump Dimensions: 37" x 26.5" x 15.7"
- Weight: 844 lbs

LK SERIES - Clean Water, Nickel Plated Spheroidal Cast Iron Pump Head

LKN SERIES - Chemical Compatibility Duplex ASTM F51 Stainless Steel Block Style Pump Head



- Solid Shaft
- Solid Ceramic Plungers
- Self-Lubricated High and Low Packing System
- Premium Quality Roller Bearings
- Water Temperature Up To 140°F
- Available in Vertical or Horizontal Versions

SR SERIES

Part No.	Part No.	GPM	PSI	RPM	Bore	Stroke	BHP
SR50	SRR50	73	5,800	1,500	50 mm	90 mm	290.0
SR55	SRR55	88	5,075		55 mm	90 mm	305.9
SR60	SRR60	105	4,350	1,800	60 mm	90 mm	312.8
SR65	SRR65	123	3,650	2,200	65 mm	90 mm	307.5
SR70	SRR70	143	3,190		70 mm	90 mm	312.4
SR75	SRR75	164	2,900		75 mm	90 mm	325.8



- Inlet Port Thread: 73 mm Flanged Port
- Discharge Port Thread: 73 mm Flanged Port
- Shaft Diameter: 65mm
- Oil Capacity: 9.25 Gal (Vert.)| 13.75 Gal (Hor.)
- Pump Dimensions: 50" x 41" x 28.5"
- Weight: 2,436 lbs

****Gear Box Options: 3 Input Gear Ratios - 1,500 RPM, 1,800 RPM, 2,200 RPM**

SR SERIES - Chemical Compatibility Duplex ASTM F51 Stainless Steel Block Style Pump Head

TR SERIES

Part No.	Part No.	GPM	PSI	RPM	Bore	Stroke	BHP
TR50	TRR50	105.0	5,800	1,500	50 mm	130 mm	417.1
TR55	TRR55	127.0	5,075		60 mm	130 mm	452.9
TR60	TRR60	152.0	4,350	1,800	70 mm	130 mm	451.5
TR65	TRR65	178.0	3,625	75 mm			
TR70	TRR70	206.0	3,200	2,200			
TR75	TRR75	237.0	2,900				



- Inlet Port Thread: 73 mm Flanged Port
- Discharge Port Thread: 73 mm Flanged Port
- Shaft Diameter: 65 mm
- Oil Capacity: 9.25 Gal (Vert.)| 13.75 Gal (Hor.)
- Pump Dimensions: 50" x 41" x 28.5"
- Weight: 2,491 lbs

****Gear Box Options: 3 Input Gear Ratios - 1,500 RPM, 1,800 RPM, 2,200 RPM**

TR SERIES HP- Chemical Compatibility Duplex ASTM F51 Stainless Steel Block Style Pump Head

LOW PRESSURE VERSIONS

VR SERIES

Part No.	GPM	PSI	RPM	Bore	Stroke	BHP
VR70	171.0	5,800	1,500	70 mm	140 mm	679.3
VR80	224.0	4,640		80 mm	140 mm	711.9
VR90	283.0	3,770	1,800	90 mm	140 mm	730.8
VR100	349.0	3,045		100 mm	140 mm	727.9
VR110	423.0	2,465		110 mm	140 mm	714.2

- Inlet Port Thread: 73 mm Flanged Port
- Discharge Port Thread: 73 mm Flanged Port
- Shaft Diameter: 65 mm
- Oil Capacity: 9.25 Gal
- Pump Dimensions: 50" x 41" x 28.5"
- Weight: 2,436 lbs

****Gear Box Options: 3 Input Gear Ratios - 1,500 RPM, 1,800 RPM, 2,200 RPM**

VR SERIES - Chemical Compatibility Duplex ASTM F51 Stainless Steel Block Style Pump Head



ZR SERIES

Part No.	GPM	PSI	RPM	Bore	Stroke	BHP
ZR70	284.0	5,800	1,500	70 mm	140 mm	1,128.2
ZR80	371.0	4,640		80 mm	140 mm	1,179.1
ZR90	470.0	3,770	1,800	90 mm	140 mm	1,213.6
ZR100	581.0	3,045		100 mm	140 mm	1,211.7
ZR110	703.0	2,465		110 mm	140 mm	1,186.9

- Inlet Port Thread: 73 mm Flanged Port
- Discharge Port Thread: 73 mm Flanged Port
- Shaft Diameter: 65 mm
- Oil Capacity: 9.25 Gal
- Pump Dimensions: 50" x 41" x 28.5"
- Weight: 2,491 lbs

****Gear Box Options: 3 Input Gear Ratios - 1,500 RPM, 1,800 RPM, 2,200 RPM**

ZR SERIES - Chemical Compatibility Duplex ASTM F51 Stainless Steel Block Style Pump Head



- Triplex Plunger Pump available in 6 Flow Rates
- High-Low Pressure Packing Design with Integrated Cooling
- Coaxial High Volumetric Efficiency Check Valves
- Splash or Pressure Lubricated Crankcase

KV SERIES

Part No.	GPM	PSI	RPM	Bore	Stroke	BHP
KV12	3.4	16,000	1,450	12 mm	26 mm	37.3
	4.1	16,000	1,750	12 mm	26 mm	44.9
KV14	4.6	11,600	1,450	14 mm	26 mm	36.5
	5.5	11,600	1,750	14 mm	26 mm	43.7

- Inlet Port Thread: 3/4" BSP-F
- Discharge Port Thread: 3/8" BSP-F
- Shaft Diameter: 30 mm
- Oil Capacity: 68 fl oz
- Pump Dimensions: 18" x 14.3" x 7.5"
- Weight: 88 lbs

KV SERIES - Clean Water, AISI420 Pump Head



VF SERIES

Part No.	GPM	PSI	RPM	Bore	Stroke	BHP
VF12	3.4	21,750	750	12 mm	50 mm	37.3
	4	17,400	1,000	12 mm	50 mm	44.9
VF14	4.6	15,950	750	14 mm	50 mm	36.5
	6.1	11,600	1,000	14 mm	50 mm	43.7

- Inlet Port Thread: 3/4" BSP-F
- Discharge Port Thread: 8 mm Flanged Port
- Shaft Diameter: 30 mm
- Oil Capacity: 128.5 fl oz
- Pump Dimensions: 23.8" x 15.1" x 8.8"
- Weight: 139 lbs

VF SERIES - Clean Water, AISI420 Pump Head



VK SERIES

Part No.	GPM	PSI	RPM	Bore	Stroke	BHP
VK12	5.3	21,750	1,500	12 mm	50 mm	79.0
	5.3	21,750	1,800	12 mm	50 mm	79.0
	5.3	21,750	2,200	12 mm	50 mm	79.0
VK14	5.3	15,950	1500	14 mm	50 mm	57.9
	5.3	15,950	1800	14 mm	50 mm	57.9
	5.3	15,950	2,200	14 mm	50 mm	57.9

- Inlet Port Thread: 3/4" BSP-F
- Discharge Port Thread: 8 mm Flanged Port
- Shaft Diameter: 40 mm
- Oil Capacity: 128.5 fl oz
- Pump Dimensions: 25.4" x 19" x 9.8"
- Weight: 176 lbs

Pump Available with Gear Reducer Input Speed of 1,500 RPM, 1,800 RPM, 2,200 RPM

VK SERIES - Clean Water, AISI420 Pump Head



SM SERIES

Part No.	GPM	PSI	RPM	Bore	Stroke	BHP
SM14	6.9	21,750	1,500	14 mm	70 mm	102.8
SM16	9	17,400		16 mm	70 mm	107.3
SM18	11.4	13,050		18 mm	70 mm	101.9
SM20	14	10,875		20 mm	70 mm	104.3
SM22	16.9	8,700		22 mm	70 mm	100.7
SM24	20.1	7,250		24 mm	70 mm	99.8

- Inlet Port Thread: 1 1/2" BSP-F
- Discharge Port Thread: 13 mm Flanged Port
- Shaft Diameter: 50 mm
- Oil Capacity: 2.38 Gal
- Pump Dimensions: 34.6" x 21.2" x 14.5"
- Weight: 573 lbs

Gear Box Options: 4 Input Gear Ratios - 1,500 RPM, 1,800 RPM, 2,200 RPM, 2,600 RPM

SM SERIES - Clean Water, AISI420 Pump Head



NOTE:
KV SERIES
Add SPF to the end of any Part Number for SAE J744-B Hydraulic Flange with 13T 16/32DP Hollow Shaft Spline

NOTE:
VF, VK, SM SERIES
Add SPF to the end of any Part Number for SAE J744-C Hydraulic Flange with 14T 12/24DP Hollow Shaft Spline

SK SERIES

Part No.	GPM	PSI	RPM	Bore	Stroke	BHP
SK20	11.4	21,750	1,500	20 mm	90 mm	169.8
	11.6	21,750	1,750	20 mm	90 mm	172.8
SK22	13.7	18,850	1,500	22 mm	90 mm	176.9
	14	18,850	1,750	22 mm	90 mm	180.8
SK24	16.4	15,950	1,500	24 mm	90 mm	179.2
	16.6	15,950	1,750	24 mm	90 mm	181.3
SK26	19.3	13,050	1,500	26 mm	90 mm	172.5
	19.6	13,050	1,750	26 mm	90 mm	175.2
SK28	22.3	11,600	1,500	28 mm	90 mm	177.2
	22.7	11,600	1,750	28 mm	90 mm	180.4
SK30	25.4	10,150	1,500	30 mm	90 mm	176.6
	25.6	10,150	1,750	30 mm	90 mm	178.0

- Inlet Port Thread: 1 1/2" BSP-Ft
- Discharge Port Thread: 14 mm Flanged Port
- Shaft Diameter: 50 mm
- Oil Capacity: 3.6 Gal
- Pump Dimensions: 42" x 26.5" x 13.72"
- Weight: 855 lbs

SK SERIES - Clean Water, AISI420 Pump Head



SR SERIES

Part No.	GPM	PSI	RPM	Bore	Stroke	BHP
SR26 hp	19.9	2,1750	1,500	26 mm	90 mm	296.5
SR30 hp	26.5	1,7400		30 mm	90 mm	315.8
SR32 hp	29.5	1,4500	1,800	32 mm	90 mm	293.0
SR36 hp	29.8	11,600	2,200	36 mm	90 mm	236.8

- Inlet Port Thread: 2" BSP-Ft
- Discharge Port Thread: 19 mm Flanged Port
- Shaft Diameter: 65 mm
- Oil Capacity: 9.25 Gal (Vert.) | 13.75 Gal (Hor.)
- Pump Dimensions: 54" x 41" x 28.5"
- Weight: 2321 lbs
- Available in Vertical or Horizontal Versions

Gear Box Options: 3 Input Gear Ratios - 1,500 RPM, 1,800 RPM, 2,200 RPM

SR SERIES - Clean Water, 17/4ph Stainless Steel Pump Head and Check Valves

TR SERIES

Part No.	GPM	PSI	RPM	Bore	Stroke	BHP
TR26 hp	28.5	21,750	1,500	26 mm	130 mm	424.6
TR30 hp	37.8	17,400		30 mm	130 mm	450.5
TR32 hp	43	14,500	1,800	32 mm	130 mm	427.1
TR36 hp	54.4 GPM	11,600	2,200	36 mm	130 mm	432.2

- Inlet Port Thread: 2" BSP-Ft
- Discharge Port Thread: 19 mm Flanged Port
- Shaft Diameter: 65 mm
- Oil Capacity: 9.25 Gal (Vert.) | 13.75 Gal (Hor.)
- Pump Dimensions: 54" x 41" x 28.5"
- Weight: 2321 lbs
- Available in Vertical or Horizontal Versions

Gear Box Options: 3 Input Gear Ratios - 1,500 RPM, 1,800 RPM, 2,200 RPM

TR SERIES - Clean Water, 17/4ph Stainless Steel Pump Head and Check Valves



MW & MF SERIES

Part No.	Description
PRK1150	Outlet Plug 1-1/4" BSPM
PRK1151	Nipple 1-1/4" BSPM x 1-1/2"BSPM
PRK1152	Nipple 1-1/4" BSPM x 1-1/4"BSPM
PRK1153	Inlet Closure Flange
PRK1154	Inlet Elbow Flange 76 mm OD
PRK1155	Inlet Flange 2-1/2" BSPF
PRK1232	Inlet Flange 2-1/2" NPF
PRK1156	Inlet Hose Adaptor 76 mm OD

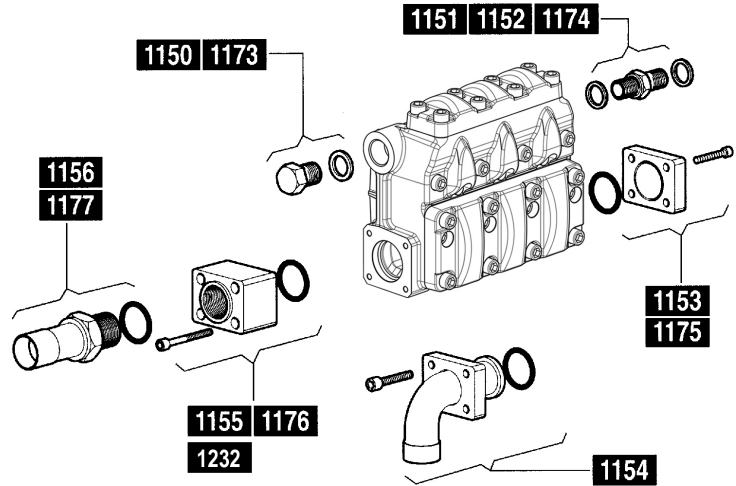

MWN & MWNR SERIES

Part No.	Description
PRK1173	Outlet Plug 1-1/4" BSPM
PRK1174	Nipple 1-1/4" BSPM x 1-1/4"BSPM
PRK1175	Inlet Closure Flange
PRK1176	Inlet Flange 2-1/2" BSPF
PRK1177	Inlet Hose Adaptor 76 mm OD

SM & SK SERIES

Part No.	Description
PRK1103	Adaptor 1/2" BSPM/F
PRK1104	High Pressure Plug 1/2" BSPM
PRK1125	Inlet Plug 1-1/2" BSPM
PRK1126	Adaptor 1/2" BSPM x 5/8" UNF
PRK1127	Outlet Flange 3/4" BSPF
PRK1128	High Pressure Plug 3/4" BSPM
PRK1129	HP Nipple 3/4" BSPM x 3/8" BSPM
PRK1130	HP Nipple 3/4" BSPM x M20 x 1.5
PRK1131	HP Nipple 3/4" BSPM x M22 x 1.5
PRK1132	HP Nipple 3/4" BSPM x M24 x 1.5

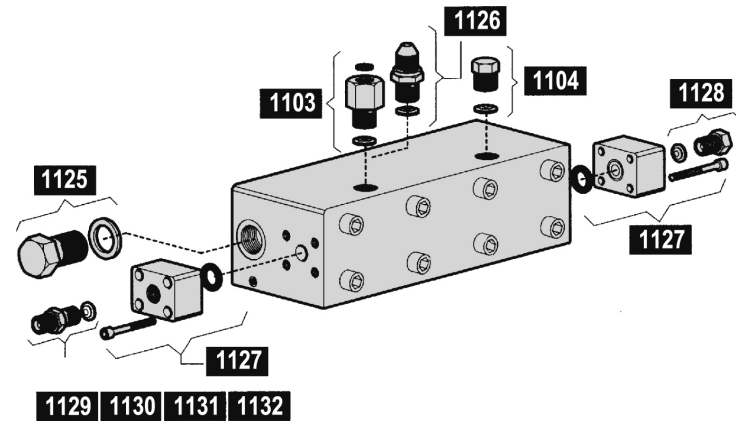

VH, VF, VK & VFH SERIES

Part No.	Description
PRK1041	Inlet Plug 3/4" BSPM
PRK1103	Adaptor 1/2" BSPM/F
PRK1104	High Pressure Plug 1/2" BSPM
PRK1105	HP Nipple 1/2" BSPM x 1/4" BSPM
PRK1106	HP Nipple 1/2" BSPM x 3/8" BSPM
PRK1107	HP Nipple 1/2" BSPM x M14 x 1.5
PRK1108	HP Nipple 1/2" BSPM x M20 x 1.5
PRK1109	HP Nipple 1/2" BSPM x M22 x 1.5
PRK1110	HP Nipple 1/2" BSPM x M24 x 1.5
PRK1257	Outlet Flange 1/2" BSPF

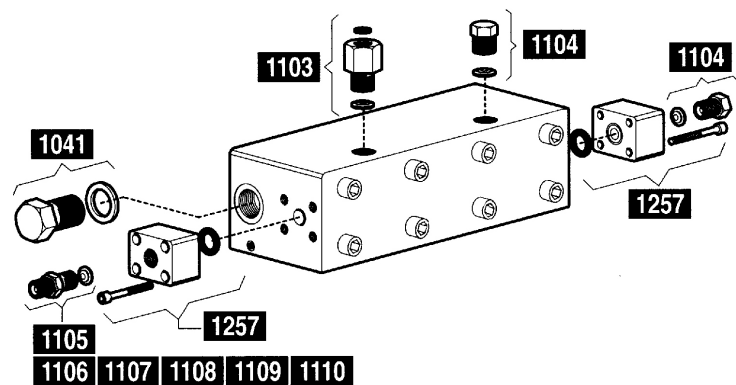

MKLP, MKRLP, MKSLP & MKSRLP SERIES

Part No.	Description
PRK1150	Outlet Plug 1-1/4" BSPM
PRK1151	Nipple 1-1/4" BSPM x 1-1/2" BSPM
PRK1152	Nipple 1-1/4" BSPM x 1-1/4" BSPM
PRK1201	Inlet Closure Flange
PRK1202	Inlet Flange 3" BPSF
PRK1299	Inlet Flange 3" NPTF
PRK1203	Inlet Hose Adaptor 90 mm OD

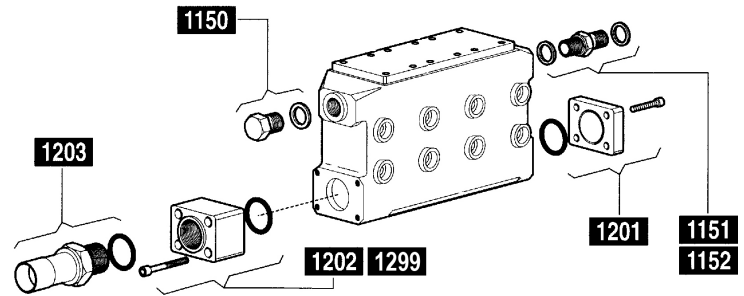

LKLP SERIES

Part No.	Description
PRK1151	Nipple 1-1/4" BSPM x 1-1/2" BSPM
PRK1152	Nipple 1-1/4" BSPM x 1-1/4" BSPM
PRK1201	Inlet Closure Flange
PRK1202	Inlet Flange 3" BPSF
PRK1299	Inlet Flange 3" NPTF
PRK1203	Inlet Hose Adaptor 90 mm OD
PRK1214	Outlet Connection Flange 1-1/4" BSPF
PRK1215	Outlet Closure Flange

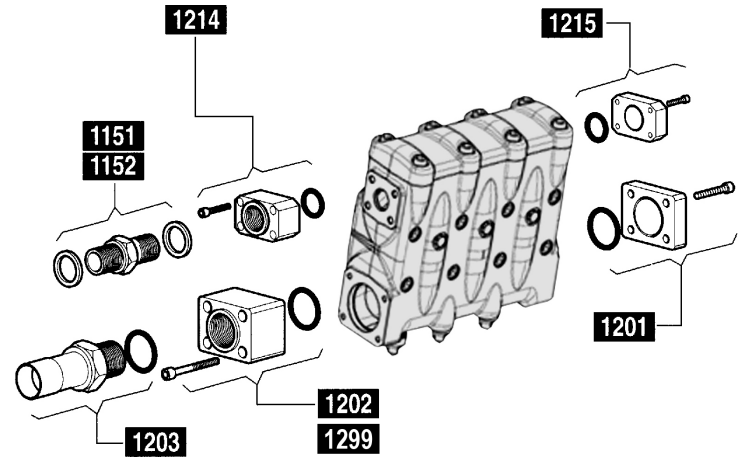

LKN LP SERIES

Part No.	Description
PRK1174	Nipple 1-1/4" BSPM x 1-1/4" BSPM
PRK1227	Inlet Closure Flange
PRK1228	Outlet Flange 3" BPSF
PRK1229	Inlet Hose Adaptor 90 mm OD
PRK1230	Inlet Connection Flange 1-1/4" BSPF
PRK1231	Inlet Closure Flange

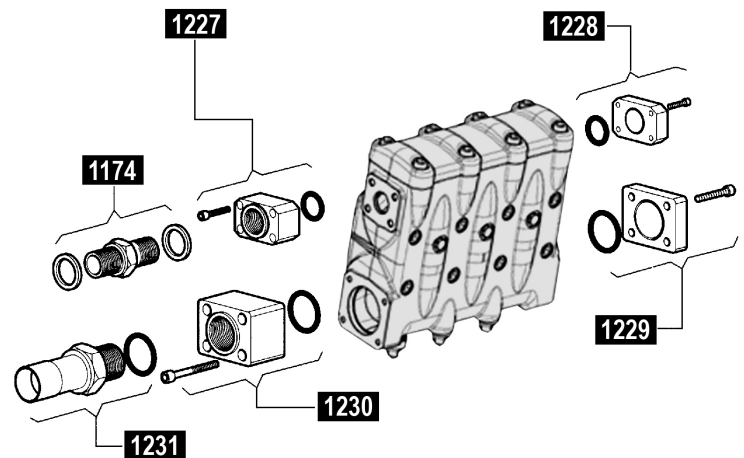

- Self-Priming
- Run Dry without Damage
- Portable Water Systems
- Variety of Chemical Resistant Materials
- Pole Window Cleaning
- Chemical Transfer/Injection
- Automotive Systems
- Agricultural/Horticultural Sprayers
- Dust Suppression Systems

DUPLEX SERIES

Part No.	Flow	Pressure	Voltage	Switch	Bypass	Cams	Seals
2130132	2.15 GPM	85 PSI	12 v	95 PSI	85 PSI	2	EPDM/EPDM
2130032	1.8 GPM	95 PSI	115 v	95 PSI	85 PSI	2	EPDM/EPDM

- Max Temperature: 160°F
- Rotating 90° Increments Ports
- Excellent Self Priming Capabilities
- Port Size: 1/4" NPT-F Inlet/Outlet
- Choice of Chemical Resistant Materials
- Self Priming: 8 ft/2.4 m Dry

Part No.	Flow	Pressure	Voltage	Bypass	Seals
2100032	2.0 GPM	50 PSI	115 v	70 PSI	Santoprene

- Max Temperature: 130°F
- Rotating 90° Increments Ports
- Excellent Self Priming Capabilities
- Port Size: 3/8" NPT-F Inlet/Outlet
- Choice of Chemical Resistant Materials
- Self Priming: 5 ft/1.5 m Dry



DUPLEX II SERIES

Part No.	Flow	Pressure	Voltage	Switch	Bypass	Cams	Seals
2100535	2.35 GPM	50 PSI	12 v	-	-	5	Santoprene/Santoprene
2100573	2.15 GPM	50 PSI	12 v	-	-	2	Santoprene/Santoprene
D3131E1311A	1.60 GPM	50 PSI	12 v	-	50 PSI	3	EPDM/EPDM
D3131V5011A	2.15 GPM	50 PSI	12 v	-	-	2	Viton/Viton
D3131H5011A	2.15 GPM	50 PSI	12 v	60 PSI	-	2	Santoprene/Santoprene
D2131I1311A	1.60 GPM	50 PSI	12 v	-	50 PSI	2	Buna/Viton
D3134H1311A	1.60 GPM	50 PSI	12 v	-	50 PSI	2	Santoprene/EPDM
D3135E7011A	2.00 GPM	100 PSI	12 v	100 PSI	-	3	EPDM/EPDM
D21X007A	2.1 GPM	50 PSI	12 v	-	50 PSI	2	Viton/Buna
D31X015F	2.00 GPM	50 PSI	12 v	-	50 PSI	3	Buna/Buna
2100332	2.15 GPM	50 PSI	24 v	60 PSI	-	2	Santoprene/Santoprene
D3231B5011A	2.00 GPM	60 PSI	24 v	60 PSI	-	2	Buna/Buna
2100032	1.85 GPM	50 PSI	115 v	60 PSI	-	2	Santoprene/Santoprene
D1625F1411A	2.2 GPM	100 PSI	115 v	-	-	-	Viton/EPDM
D1635J7011A	1.4 GPM	70 PSI	115 v	-	-	-	Viton/Santo

- Max Temperature: 160°F
- 12 volt, 24 volt, 115 volt
- Excellent Self Priming Capabilities
- Port Size: 3/8" NPT Inlet/Outlet
- Choice of Chemical Resistant Materials
- Self Priming: Up to 8' Dry



VERSIJET SERIES - HIGH CAPACITY

Part No.	Flow	Pressure	Voltage
R8400134A	4.0 GPM	70 PSI	12 v
R8600134A	6.0 GPM	70 PSI	12 v

- Port Size: 1/2" Inlet, 3/4" Outlet
- Santoprene Diaphragms
- Viton Check Valves



QUAD SERIES

Part No.	Flow	Pressure	Voltage	Switch	Cams	Seals
4100505	3.50 GPM	40 PSI	12 v	-	2	Santoprene/EPDM
4100512	5.00 GPM	40 PSI	115 v		3	Santoprene/Viton
4300142	3.50 GPM	40 PSI	12 v	45 PSI	2	Santoprene/EPDM
4300143	5.00 GPM	40 PSI	12 v	45 PSI	3	Santoprene/EPDM
4300500	3.50 GPM	40 PSI	12 v	45 PSI	2	Santoprene/Viton
4300042	3.50 GPM	40 PSI	115 v	45 PSI	2	Santoprene/EPDM
4300043	5.00 GPM	40 PSI	115 v	45 PSI	3	Santoprene/EPDM
4300342	3.50 GPM	40 PSI	24 v	45 PSI	2	Santoprene/EPDM



- Max Temperature: 130°F
- Housing: Polypropylene
- Excellent Self Priming Capabilities
- Port Size: 1/2" HB Inlet, 3/4" HB Outlet
- Choice Of Chemical Resistant Materials
- Self Priming Up to 8' (Dry)

AIR OPERATED SERIES

Part No.	Flow	Pressure	Inlet/Outlet	Seals	Weight
5100020	1.9 GPM	60 PSI	3/8" Barb	Viton	1.3 lbs
5100040	1.9 GPM	75 PSI	3/8" Barb	Santoprene	1.4 lbs



- Housing: Acetal Copolymer
- Operating Pressure: 75 PSI Max
- Fluid Temperature: 120°F Max
- Air Supply Inlet: 1/4" Hose Barb
- Positive Displacement Double Diaphragm Design
- Air Pressure: 80 PSI Max
- Fluid Inlet Pressure: 15 PSI Max
- Self-Priming: 28 ft/8.5 m Dry
32 ft/9.8 m Wet

Part No.	Flow	Pressure	Inlet/Outlet	Seals	Weight
G573205A	5.0 GPM	100 PSI	3/8" Barb	Viton	1.2 lbs
G573215A	5.0 GPM	100 PSI	1/2" Barb	Viton	1.2 lbs
G575205A	5.0 GPM	100 PSI	3/8" Barb	Santoprene	1.2 lbs
G575215A	5.0 GPM	100 PSI	1/2" Barb	Santoprene	1.2 lbs



- Housing: Polypropylene
- Operating Pressure: 20-100 PSI
- Fluid Temperature: 110°F Max
- Air Supply Inlet: 1/4" Hose Barb
- Positive Displacement Double Diaphragm Design
- Air Pressure: 20-100 PSI
- Fluid Inlet Pressure: 30 PSI Max
- Self-Priming: 15 ft/4.5 m Dry
20 ft/4.5 m Dry

Part No.	Flow	Pressure	Inlet/Outlet	Seals	Weight
G257301A	10 GPM	Up to 90 PSI	1/2" Barb	Viton	3.5 lbs
G257302A	10 GPM	Up to 90 PSI	1/2" Barb	Viton	3.5 lbs
G257501A	10 GPM	Up to 90 PSI	1/2" Barb	Santoprene	3.5 lbs
G257502A	10 GPM	Up to 90 PSI	1/2" Barb	Santoprene	3.5 lbs



- Housing: Polypropylene
- Operating Pressure: 20-100 PSI
- Fluid Temperature: 110°F Max
- Air Supply Inlet: 1/4" Hose Barb
- Positive Displacement Double Diaphragm Design
- Air Pressure: 20-100 PSI
- Fluid Inlet Pressure: 30 PSI Max
- Self-Priming: 15 ft/4.5 m Dry
20 ft/4.5 m Dry

CALCULATIONS

BELT LENGTH

$$BL = 2L + \frac{\pi(D + d)}{2} + \frac{(D - d)}{4L}$$

BL = Belt Length (inches)
 L = Center to Center Distance
 D = The Large Pulley Diameter
 d = The Small Pulley Diameter

BELT DEFLECTION

$$BD = L \times .016$$

BD = Belt Deflection (inches)

MOTOR / PUMP SPEED

$$\frac{\text{Motor Pulley OD}}{\text{Pump RPM}} = \frac{\text{Pump Pulley OD}}{\text{Motor RPM}}$$

FLOW RATE / PUMP SPEED

$$\frac{\text{Rated GPM}}{\text{Rated RPM}} = \frac{\text{Desired GPM}}{\text{Desired RPM}}$$

HORSE POWER REQUIREMENTS

$$\text{Electric Brake HP} = \frac{\text{GPM} \times \text{PSI}}{1460}$$

$$\text{Industrial Gasoline or Diesel HP} = \frac{\text{GPM} \times \text{PSI}}{1100}$$

$$\text{Hydraulic HP} = \frac{\text{GPM} \times \text{PSI}}{1714}$$

NOZZLE SELECTION

$$\text{Nozzle \#} = \text{GPM} \sqrt{\frac{4000}{\text{PSI}}}$$

IMPACT OR REACTANT FORCE

$$I (\text{lbsf}) = .0526 \times \text{GPM} \times \sqrt{\text{PSI}}$$

WATER VELOCITY

$$V = \frac{\text{Flow Rate (GPM)} \times .0321}{\text{Pipe Area}}$$

RECIPROCATING PUMP MAXIMUM INLET VELOCITY

2 ft/sec

AREA OF A PIPE

$$A = \frac{\pi D^2}{4}$$

π = pie 3.14159
 D = Diameter of Pipe (inches²)

CONVERSIONS

IMPERIAL TO METRIC

Length

in	Multiply by	0.0254 m
ft	Multiply by	0.3048 m
mile	Multiply by	1.61 km

Mass

lbs	Multiply by	0.455 kg
-----	-------------	----------

Flow Rate

US GPM	Multiply by	3.79 lpm
US GPM	Multiply by	0.004 m ³ /min
US GPM	Multiply by	0.017 gph

Pressure

PSI	Multiply by	0.07 bar
PSI	Multiply by	0.145 kpa
ft of head	Multiply by	0.433 PSI

Torque

ft*lbs	Multiply by	1.36 Nm
--------	-------------	---------

Volume

US gal	Multiply by	3.79 L
--------	-------------	--------

Temperature

°F	(F - 32) * 5/9	°C
----	----------------	----

METRIC TO IMPERIAL

Length

m	Multiply by	39.37 in
m	Multiply by	3.28 ft
km	Multiply by	0.621 mile

Mass

kg	Multiply by	2.2 lbs
----	-------------	---------

Flow Rate

lpm	Multiply by	0.264 US GPM
m ³ /min	Multiply by	264 US GPM
gph	Multiply by	60 US GPM

Pressure

bar	Multiply by	14.5 PSI
kpa	Multiply by	0.145 PSI
PSI	Multiply by	2.31 ft of head

Torque

Nm	Multiply by	0.738 ft*lbs
----	-------------	--------------

Volume

L	Multiply by	0.264 US gal
---	-------------	--------------

Temperature

°C	(C * 9/5) + 32	°F
----	----------------	----

STANDARD INLET PLUMBING "RULES OF THUMB"

- Twice the plunger pump volume to be supplied to the pump.
- Inlet filtration oversized (2 - 3 times the pump volume) up to 5 times if hot water is pumped through the pump.
- Minimized suction line length.
- Smooth plumbing. (no elbows or tees)
- Pressurized suction line (Max 45 PSI) optimum conditions.
- All inlet plumbing to be at least 1 size larger than the inlet of the pump.
- Inlet to be flexible non-collapsible hose.
- Water inlet flow to enter on one side of the pump only.
- All connection must be airtight.
- If water is bypassed back into the inlet a regulator cannot use used.
- Bypass hose must be flexible hose, not wire braided pressure hose.
- Bypass loop can be longer and coiled to provide for more fluid flow for cooling.
- Bypass return leg to be reintroduced back to the inlet as to not induce excessive turbulence in the inlet of the pump.
- Inlet flow not to exceed .5 meters per second.
- Bottom port of unloader valves, should not be used if more that 40% of the unloader valves capacity is pushed through the valve (this value may vary from one valve to the next).

FRICITION LOSS IN PIPE FITTINGS IN EQUIVALENT FEET OF PIPE

Fitting Type	Fitting Size (inches)						
	1/2	3/4	1	1 1/4	1 1/2	2	2 1/2
90° Std Elbow	1.6	2.1	2.6	3.5	4	5.5	6.2
90° Long Elbow	1	1.4	1.7	2.3	2.7	4.3	5.1
90° Street Elbow	3	3.4	4.4	5.8	6.7	8.6	10.3
45° Std Elbow	0.8	1.1	1.4	1.8	2.1	2.8	3.3
45° Street Elbow	1	1.8	2.3	3	3.5	4.5	5.4
Square Elbow	3	3.9	5	6.5	7.6	9.8	11.7
Std Tee Straight Run	1	1.4	1.7	2.3	2.7	4.3	5.1
Std Tee Branch Run	4	5.1	6	6.9	8.1	12	14.3

PRESSURE LOSS (PSI PER 100 FEET OF HOSE)

Water Flow in US Gal./Min	Actual Internal Diameter (inches)											
	1/4	5/16	3/8	1/2	5/8	3/4	1	1 1/4	1 1/2	2	2 1/2	3
0.5	16	5	2									
1	54	20	7	2								
2	180	60	25	6	2							
3	380	120	50	13	4	2						
4		220	90	24	7	3						
5		320	130	34	10	4						
6			220	52	16	7	1					
8			300	80	25	10	2	1				
10				120	38	14	3	2	1			
15				250	80	30	7	4	2			
20					120	50	12	6	3	1		
25					200	76	19	9	4	1		
40					410	162	42	15	6	2	1	
60							93	32	13	3	1	
70							370	126	43	18	4	1
80									55	23	5	2
90									68	28	7	2
100									82	34	8	3
125									124	51	12	4
150										72	18	7

THE IDEAL SUPPLY TANK DESIGN

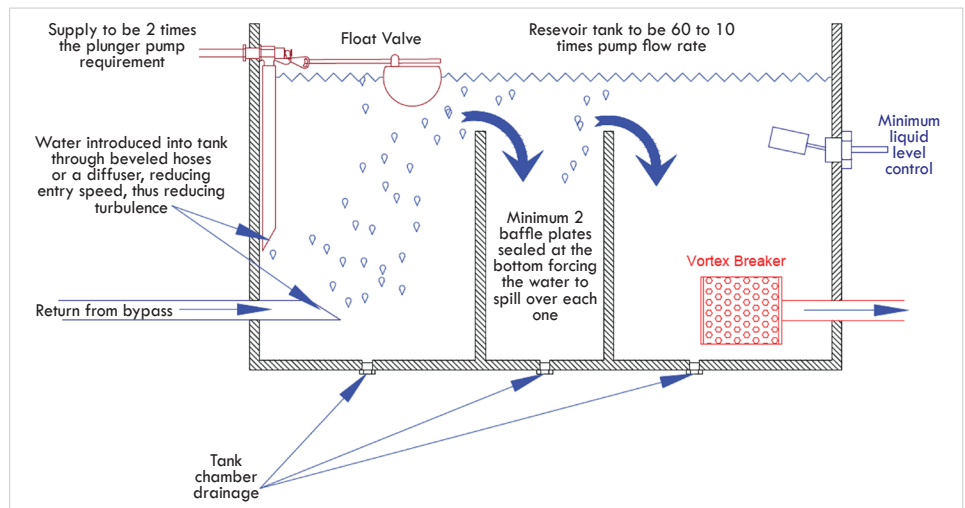

WARRANTY

WARRANTY INFORMATION

Products are warranted to be free from defects in materials and workmanship under normal use and service, for a period of (1) one year from the date of purchase, unless stated otherwise below, when operated and maintained in accordance with the Maintenance and Operation Instructions supplied with the unit. The Warranty does not cover misuse or negligence.

All pressure washer accessories (hoses, spray guns, nozzles and other) are warranted to the original purchaser to be free from defects in materials and workmanship under normal use and service. "Normal use and service" means: used within the recommended pressure, temperature, flow rate and fluid handling compatibilities. The period for these accessories is 90 days from the date of purchase. Single angle spray nozzles are not covered under any warranty as they are wear items.

If a difficulty develops with the product, you should contact an Authorized Service Center or John Brooks Company Limited office nearest to you. Only those locations are authorized to make repairs to the product or replace defective parts, which will be done at no charge within a reasonable time after receipt of product. Units or parts should be returned at the customer's expense to the nearest Authorized Service Center or John Brooks Company Limited office. Pack unit in a strong carton and pad tightly to avoid damage. Damage in transit is not covered by warranty. Include original purchase receipt with any claim (but keep a copy for your files).

John Brooks Company Limited's liability under warranty is limited to the repair of the product and/ or replacement parts and is given to the purchaser in lieu of all other remedies including incidental and consequential charges. There are no express warranties other than those herein.

The forgoing warranty is exclusive and in lieu of all other warranties, expressed or implied whether arising by operation of law, trade custom, course of dealings or otherwise, including warranties of merchantability and fitness for a particular purpose.

PUMP WARRANTY INFORMATION

The following statement is intended to assist our customers in understanding the terms of our warranty, the circumstances under which we will honor claims and the procedure for making such claims.

John Brooks Company Limited warrants each pump manufactured by the Interpump Group to be free of defects in material and workmanship for the period of (5) five years from date of shipment, with the exception of the 57 Series (TV/TH). Pratissoli Pumps are free from defects in materials and workmanship for a period of (5) five years. Liability under this warranty is on non-wear parts and limited to the repair, or replacement of any pump returned to John Brooks Company Limited which upon inspection, is judged to be defective as a result of workmanship or material failure.

All products returned to John Brooks Company Limited must display a Warranty Claim Number (WCF). A WCF number can be obtained by calling (905)-567-9222 or 1-888-881-6667 and speaking with a Customer Service Representative. All returned product must arrive freight prepaid to: **John Brooks Company Limited • 2625 Meadowpine Blvd • Mississauga, ON • L5N 7K5**

In the course of marketing or servicing the customer or potential customer's need, John Brooks Company Limited will use its best judgement in their recommendations. However, the ultimate responsibility for the product application decisions shall rest with the customer. The sole and only warranty made by John Brooks Company Limited, is the limited warranty described above. John Brooks Company Limited is expressly limited to the replacement or purchase price of the product.

Items NOT considered as warrantable failures:

- Normal wear and tear: packings, check valves, oil or mechanical seals
- Application related failures: damage resulting from freezing
- Pump head washout or erosion
- Damage resulting from cavitation
- Material erosion resulting from chemical attack
- Damage resulting from extraneous fluid conditions (i.e. hard water)
- Neglect or poor maintenance

Third Party: Use of non-original parts, modifications made by the customer

Warranty does not apply to any pumps or pump part not obtained from John Brooks Company Limited. This warranty statement supersedes and replaces non-dated warranties.

TERMS AND CONDITIONS

1. Payment terms are NET 30 DAYS from the date of invoice unless agreed otherwise in writing.
2. Claims for adjustment or short shipment must be made within 15 days of the date of invoice.
3. A service charge will be added to all past due accounts at the rate of 1.5% per month (18% per annum calculated monthly).
4. New Minimum Billing: \$75.00
5. No merchandise will be accepted for credit of warranty adjustment unless pre-authorized by our company.
6. Returned goods must be in a saleable condition.
7. All returns must be FOB our warehouse.
8. A minimum re-stocking charge of \$25.00 or 25% will apply to all merchandise accepted for return, whichever amount is higher.
9. Non-stock and special order items are not subject to cancellation once the product has shipped from our supplier or has been put into production.
10. The seller warrants that the goods are free from defects in material and workmanship under normal and proper usage for a period of warranty provided by the original manufacturer of goods. - The forgoing warranty is exclusive and in lieu of all other warranties, expressed or implied whether arising by operation of law, trade custom, course of dealings or otherwise, including warranties of merchantability and fitness for a particular purpose.

HEAD OFFICE
2625 Meadowpine Blvd.
Mississauga, ON
L5N 7K5

LAVAL
4101 Boul Industriel.
Laval, QC
H7L 6G9

EDMONTON
6736 - 59th Street NW.
Edmonton, AB
T6B 3N6

Dynablast

JOHN BROOKS

DYNABLAST.CA | 1-888-881-6667

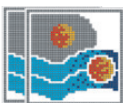

Pratissoli

